

## 4K Vandal Resistant Outdoor Dome Network Camera with AI engine

The WV-X2571LN has onboard AI functionality. AI-based high precision analysis helps surveillance operations and crime prevention operations more efficiently, whereas these operations previously required dedicated manpower.

There are 3 AI functions available through the camera: detecting suspicious changes in captured scenes, optimizing the image settings of the camera (based on captured scene analysis) for better image usability, and optimizing video compression through captured scenes to save bandwidth at 50%\* lower than existing cameras while maintaining image quality.

\*Compared to Smart Coding OFF with H.265

### Optimization of image quality and data compression using AI

- AI detects, identifies and determines movement.
- AI determines human faces and captures them in the most visible state.
- AI determines moving objects, identifies where there is no movement, and performs efficient data compression.

### 3rd party relationship

- To enable 3rd party companies to develop their applications using SDK.
- Users can freely combine applications and introduce analysis software that is the best match for their requirements.

### Easy installation

- AI analysis automatically applies optimal settings, allowing you to capture high-quality images effortlessly.
- Connect the network cable to the camera body simply by opening a part of the packaging, saving you time and working space.

### Key Features

- 4K (3,840 x 2,160) up to 30fps
- AI Intelligent Auto
- Color night vision (0.006 to 0.09 lx)
- H.265 Smart Coding
- ClearSight Coating
- FIPS140-2 CAVP compliant

\*Using encryption module standardized by FIPS publication 140-2

- ONVIF® Profile G / M / S / T

\*ONVIF is a trademark of ONVIF, Inc.

### Industry examples

- Safe Cities
- Transportation (Airport / Train, Subway station)
- Bank (ATM, Entrance)
- Retail / Logistics / Education / Hospital / Building



# Specifications

<b>Camera</b>	Image Sensor	1/1.8 type CMOS image sensor
	Minimum Illumination	Color : 0.09 lx, BW : 0.05 lx (F1.5, Maximum shutter : Off (1/30s), AGC : 11) BW : 0 lx (F1.5, Maximum shutter : Off (1/30 s), AGC : 11, when the IR LED is lit) Color : 0.006 lx, BW : 0.003 lx (F1.5, Maximum shutter : max. 16/30s, AGC : 11) <sup>*1</sup>
	White Balance	ATW1/ATW2/AWC
	Shutter Speed	[30fps mode] 1/30 Fix to 1/10000 Fix [25fps mode] 1/25 Fix to 1/10000 Fix
	AI Intelligent Auto	On / Off
	Super Dynamic	On / Off. The level can be set in the range of 0 to 31.
	Dynamic Range	Max. 132 dB (Super Dynamic : On, Level : 31)
	Adaptive Black Stretch	The level can be set in the range of 0 to 255.
	Back light compensation / High light compensation	BLC (Back light compensation) / HLC (High light compensation) / Off The level can be set in the range of 0 to 31. (only when Super dynamic / AI Intelligent Auto : Off)
	Fog compensation	On / Off. The level can be set in the range of 0 to 8 (only when AI Intelligent auto / auto contrast adjust : Off)
	Maximum gain	The level can be set in the range of 0 to 11.
	Color/BW (ICR)	Off / On (IR Light Off) / On (IR Light On) / Auto1 (IR Light Off) / Auto2 (IR Light On) / Auto3 (SCC)
	IR LED Light	High / Middle / Low / Off. Maximum irradiation distance : 40 m (Approx. 131 ft)
	Digital Noise Reduction	The level can be set in the range of 0 to 255.
	Video Motion Detection (VMD)	On / Off, 4 areas available
	Scene Change Detection (SCD)	On / Off, 1 area available
	Privacy Zone	On / Off, Up to 8 zones available
	Image rotation <sup>*2 *3</sup>	0° (Off) / 90° / 180° (Upside-down) / 270°
	Camera Title (OSD)	On / Off, Up to 20 characters (alphanumeric characters, marks)
	Optical zoom	2.0x (Motorized zoom) / Motorized focus
Extra optical zoom	6.0x (when resolution is 1280x720)	
Digital (electronic) zoom	Choose from 3 levels of x1, x2, x4	
Focal length	4.3 mm - 8.6 mm {5/32 inches - 11/32 inches}	
Maximum Aperture Ratio	1 : 1.5 (WIDE) - 1 : 2.4 (TELE)	
Focus range	1 m {39-3/8 inches} - ∞	
Angular Field of View	[16 : 9 mode] * [4:3 mode] is not supported. Horizontal : 52° (TELE) - 101° (WIDE), Vertical : 29° (TELE) - 55° (WIDE)	
<b>DORI</b> <sup>*4</sup>	Detect (25ppm / 8ft)	Wide: 63.31 m / 207.71 ft, Tele: 157.46 m / 516.61 ft
	Observe (62.5ppm / 19ft)	Wide: 25.32 m / 83.08 ft, Tele: 62.99 m / 206.64 ft
	Recognize (125ppm / 38ft)	Wide: 12.66 m / 41.54 ft, Tele: 31.49 m / 103.32 ft
	Identify (250ppm / 76ft)	Wide: 6.33 m / 20.77 ft, Tele: 15.75 m / 51.66 ft
<b>Adjusting Angle</b>	Horizontal (PAN) angle : ±180°, Vertical (TILT) angle : -30 to +85°, Azimuth (YAW) angle : ±100°	
<b>Browser GUI</b>	Camera Control	Brightness, AUX On / Off
	Audio	Mic (Line) Input : On / Off Volume adjustment : Low / Middle / High Audio Output : On / Off Volume adjustment : Low / Middle / High
<b>Network</b>	GUI / Setup Menu Language	English, Italian, French, German, Spanish, Portuguese, Russian, Chinese, Japanese
	Network IF	10Base-T / 100Base-TX, RJ45 connector
	Resolution <sup>*5</sup>	[16 : 9 mode] * [4:3 mode] is not supported. 3840x2160, 2560x1440, 1920x1080, 1280x720, 640x360, 320x180
	H.265 / H.264 / Transmission Mode	Constant bit rate / VBR / Frame rate / Best effort
	H.264 <sup>*6</sup> / Transmission Type	Unicast port (AUTO) / Unicast port (MANUAL) / Multicast
JPEG / Image Quality	10 steps	
Smart Coding	<b>Smart Facial Coding</b> : On (Smart Facial Coding*) / On (Auto VIQS) / Off *Smart Facial Coding is only available with Stream(1). <b>GOP (Group of pictures) control</b> : On (Frame rate control) / On (Advanced*) / On (Mid) / On (Low) / Off *On (Frame rate control) and On (Advanced) are only available with H.265.	

\*1 Converted value  
\*2 90° and 270° are invalid only in the 320x180 resolution.  
\*3 Following the setting angle of the rotated image, the analog output of the MONITOR OUT terminal rotates.

<b>Network</b>	Audio Compression	G.726 (ADPCM) : 16 kbps / 32 kbps G.711 : 64 kbps AAC-LC <sup>*7</sup> : 64 kbps / 96 kbps / 128 kbps	
	Audio transmission mode	Off / Mic (Line) input / Audio output / Interactive (Half duplex) / Interactive (Full duplex)	
	Supported Protocol	IPv6 : TCP/IP, UDP/IP, HTTP, HTTPS, FTP, SMTP, DNS, NTP, SNMP, DHCPv6, RTP, MLD, ICMP, ARP, IEEE 802.1X, DiffServ IPv4 : TCP/IP, UDP/IP, HTTP, HTTPS, RTSP, RTP, RTP/RTCP, FTP, SMTP, DHCP, DNS, DDNS, NTP, SNMP, UPnP, IGMP, ICMP, ARP, IEEE 802.1X, DiffServ	
	No. of Simultaneous Users	Up to 14 users (Depends on network conditions)	
	SDXC/SDHC/SD Memory Card	H.265 / H.264 recording : Manual REC / Alarm REC (Pre/Post) / Schedule REC / Backup upon network failure JPEG recording : Manual REC / Alarm REC (Pre/Post) / Backup upon network failure Compatible SDXC/SDHC/SD Memory Card : Panasonic 2 GB, 4 GB*, 8 GB*, 16 GB*, 32 GB*, 64 GB**, 128 GB**, 256 GB** model *SDHC card, ** SDXC card (except miniSD card and microSD card)	
	Mobile Terminal Compatibility	iPad, iPhone, Android™ terminals	
	ONVIF® Profile	G / M / S / T	
	<b>Alarm</b>	Alarm Source : 3 terminals input, VMD alarm, SCD alarm, Command alarm Alarm Actions : SDXC/SDHC/SD memory recording, E-mail notification, HTTP alarm notification, Indication on browser, FTP image transfer, TCP alarm notification output	
	<b>Input/ Output</b>	Monitor Output (for adjustment)	VBS : 1.0 V [p-p] / 75 Ω, composite, ø3.5 mm mini jack An NTSC or PAL signal can be outputted from camera
		Audio input	ø3.5 mm stereo mini jack For microphone input : Recommended applicable microphone : Plug-in power type (Sensitivity of microphone : -48 dB±3 dB (0 dB=1 V/Pa, 1 kHz)) Input impedance : Approx. 2 kΩ (unbalanced) Supply voltage : 2.5 V ±0.5 V
Audio output <sup>*8</sup>		ø3.5 mm stereo mini jack (Audio output is monaural.) Output impedance : Approx. 600 Ω (unbalanced) Output level : -20 dBV	
External I/O Terminals		ALARM IN 1 (Alarm input 1) / Black & white input/ Auto time adjustment input (xt) ALARM IN 2 (Alarm input 2) / ALARM OUT (xt) / ALARM IN 3 (Alarm input 3) / AUX OUT (xt)	
<b>General</b>	Safety	UL (UL60950-1), c-UL (CSA C22.2 No.60950-1), CE, IEC60950-1	
	EMC	FCC (Part15 ClassA), ICES003 ClassA, EN55032 ClassB, EN55024	
	Power Source and Power Consumption	DC power supply : DC 12 V 980 mA/Approx. 11.8 W PoE (IEEE802.3af compliant) Device : DC48 V 260 mA/ Approx. 12.5 W (Class 0 device)	
	Ambient Operating Temperature	-40 °C to +60 °C (-40 °F to +140 °F) <sup>*9</sup> (Power On range : -30 °C to +60 °C (-22 °F to +140 °F))	
	Ambient Operating Humidity	10 to 100 % (no condensation)	
	Dehumidification Device	Rosahl element	
	Water and Dust Resistance	IP66 (IEC60529), Type 4X (UL50E), NEMA 4X compliant	
	Shock Resistance	50J (IEC 60068-2-75 compliant), 1K10 (IEC 62262)	
	Wind Resistance	Up to 40 m/s (approx. 89 mph)	
	Dimensions	When using base bracket : ø164 mm × 139 mm (H) [ø6-15/32 inches × 5-15/32 inches (H)] Dome radius 42 mm (1-21/32 inches) When using attachment plate only : ø154 mm × 103 mm (H) [ø6-1/16 inches × 4-1/16 inches (H)] Dome radius 42 mm (1-21/32 inches)	
Mass	When using base bracket : Approx. 1.6 kg (3.53 lbs) When using attachment plate only : Approx. 1.2 kg (2.65 lbs)		
Finish	Main body : Aluminum die cast, i-PRO white Outer fixing screws : Stainless steel (Corrosion-resistant treatment) Dome cover : Polycarbonate resin (with ClearSight coating), Clear		

\*4 Maximum distance at which a camera's tele and wide lens can meet DORI specifications. This value does not indicate the performance of the camera. Calculations made with the camera installed horizontally at resolution of 3840x2160.  
\*5 H.265/H.264 can be selected for each stream.  
\*6 Transmission for 4 streams can be individually set.  
\*7 When recording audio on an SD memory card, only use AAC-LC (Advanced Audio Coding - Low Complexity).  
\*8 This camera is not equipped with the function to change the audio output to the monitor output.  
\*9 When using with the IR LED light constantly lit, the upper limit of the operating temperature range is +50 °C (+122 °F).

# Appearance

Unit : mm (inches)

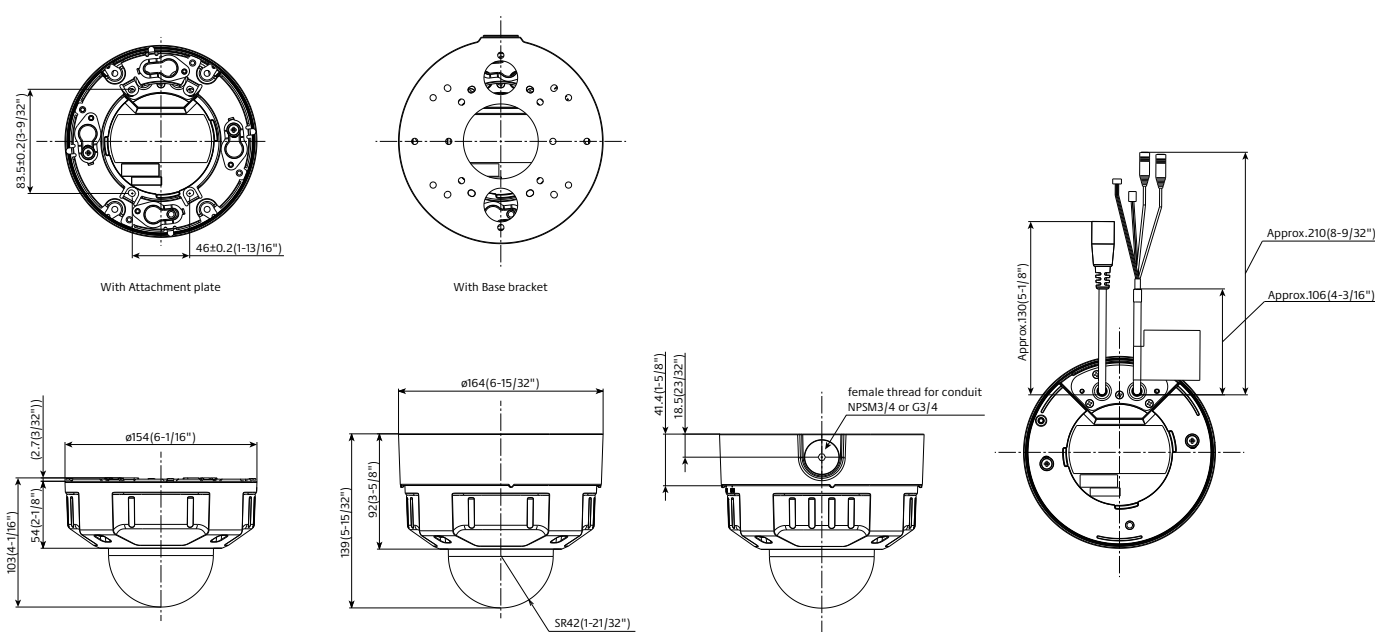

## Analytics Applications (Optional Software)

### Extension Software **WV-XAE200W**

**AI differentiates between vehicles, motorcycles, bicycles, and people. It further detects and sends warning notifications when they enter a specified area.**

#### AI Video Motion Detection



• It is possible to issue an alarm when a moving object enters a specified area.



• It is possible to issue an alarm when a moving object enters a specified area and stays there for a specified amount of time.



• It is possible to issue an alarm when a moving object enters a specified area and moves in the specified direction.

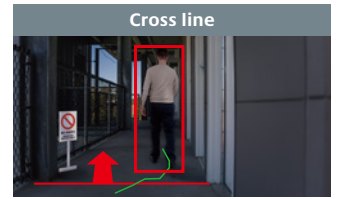

• It is possible to issue an alarm when an object moving in the specified direction crosses a specified threshold.

### Extension Software **WV-XAE201W**

**To protect privacy and portrait rights, it is possible to automatically apply a mosaic the entire face and figure of a person photographed by the camera.**

#### AI Privacy Guard



Original image



Processed image

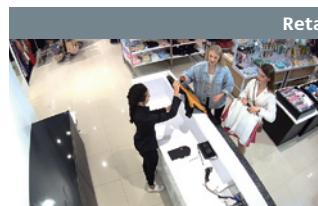



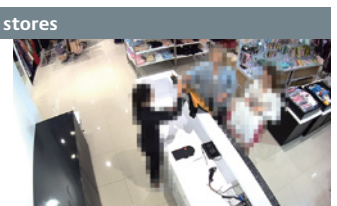









Original image



Processed image

## Optional Accessories

### Mount Bracket / Dome Cover / Other

<p>Ceiling Mount Bracket <b>WV-Q105A</b></p>  <p>* For indoor installation only</p>	<p>Ceiling Mount Bracket (Embedded) <b>WV-QEM500-W</b> (i-PRO white)</p> 	<p>Ceiling Mount Bracket <b>WV-QCL100-W</b> (i-PRO white)</p>  <p>*For indoor installation only</p>	<p>Mount Bracket <b>WV-QSR501-W</b> (i-PRO white)</p>  <p>(This bracket requires WV-QCL501-W, WV-QWL501-W or WV-QAT500-W.)</p>	<p>Ceiling Mount Bracket <b>WV-QCL501-W</b> (i-PRO white)</p>  <p>(This bracket requires WV-QSR501-W.)</p>	<p>Wall Mount Bracket <b>WV-QWL501-W</b> (i-PRO white)</p>  <p>(This bracket requires WV-QSR501-W.)</p>
<p>Wall Mount Bracket <b>WV-QWL500-W</b> (i-PRO white)</p> 	<p>Adapter Box (Embedded) <b>WV-QJB500-W</b> (i-PRO white)</p>  <p>(This bracket requires WV-QWL500-W.)</p>	<p>Sun Shade <b>WV-QSR500-W</b> (i-PRO white)</p> 	<p>Pole Mount Bracket <b>WV-QPL500-W</b> (i-PRO white)</p>  <p>(This bracket requires WV-QWL501-W.)</p>	<p>Corner Mount Bracket <b>WV-QCN500-W</b> (i-PRO white)</p>  <p>(This bracket requires WV-QWL501-W.)</p>	<p>Attachment pipe (For 3rd party bracket) <b>WV-QAT500-W</b> (i-PRO white)</p>  <p>(This bracket requires WV-QSR501-W.)</p>
<p>Dome Cover (Smoke type) <b>WV-CW7S</b> <b>WV-CW7SN</b> (Smoke type with ClearSight coating)</p> 					

• Brackets are available in four colors, Fine silver, Light gray, Gray and i-PRO white. It is possible to use them in different color combinations.

#### Trademarks and registered trademarks

- iPad and iPhone are trademarks of Apple Inc., registered in the U.S. and other countries.
- Android is a trademark of Google LLC.
- ONVIF is a trademark of ONVIF, Inc.
- All other trademarks identified herein are the property of their respective owners.

• Masses and dimensions are approximate. • Specifications are subject to change without notice.