

カメラ取り付け位置
Camera mounting position

	投影面積/Projected area (Without Adapter Box)
平面図/Top-view	0.025 (m2)
側面図/Side-view	0.023 (m2)

Weight : Approx. 1.7 kg {3.75 lbs}{(Except the Adapter Box)}

WV-S1552L

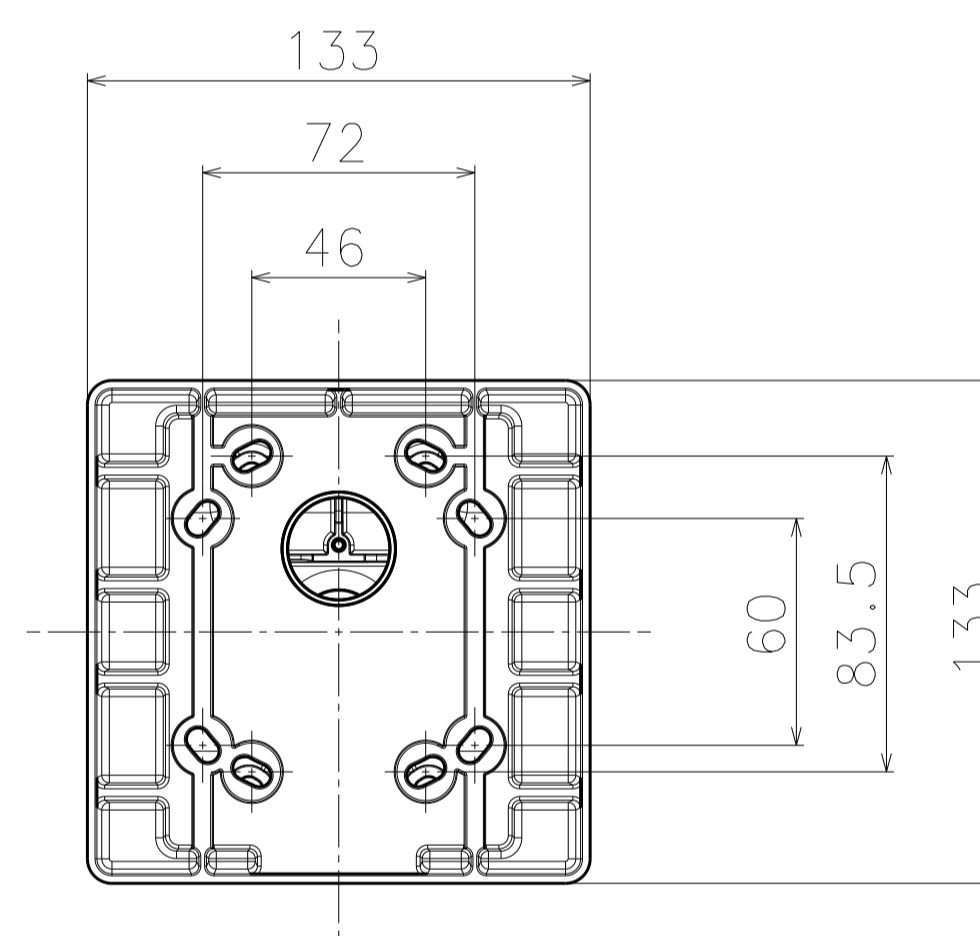
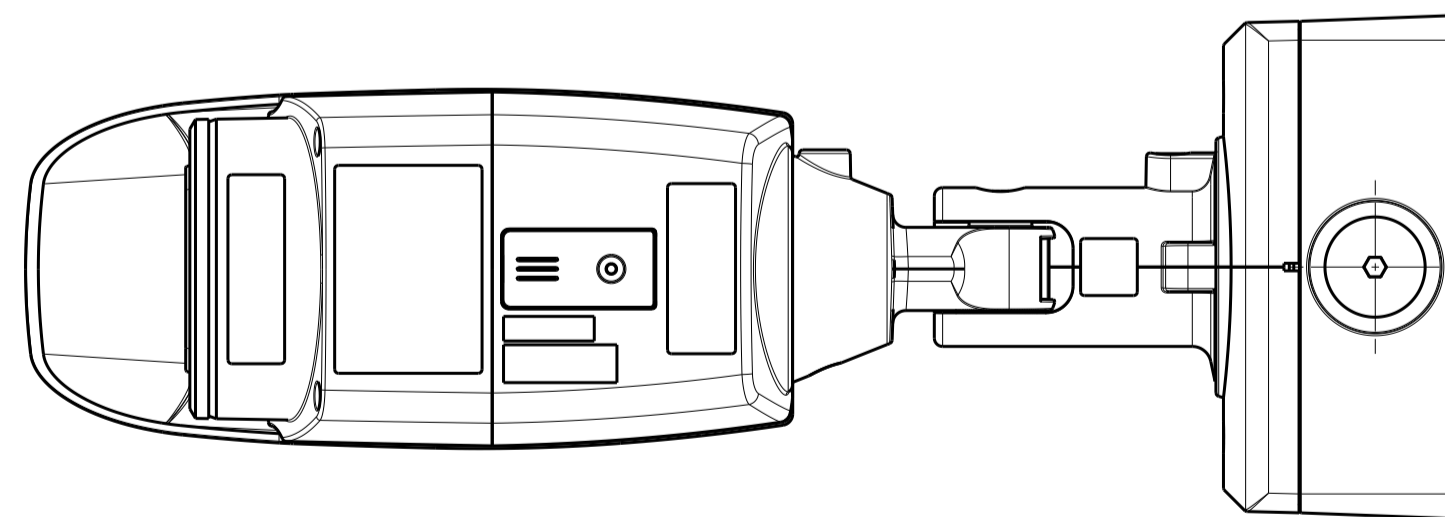
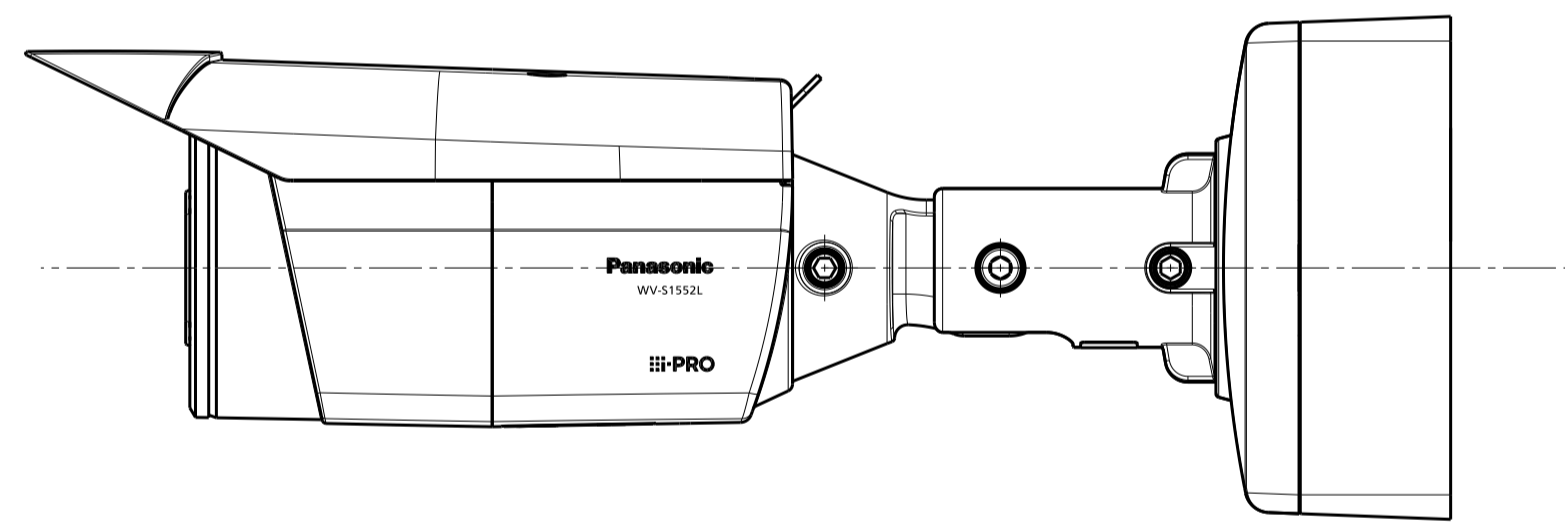
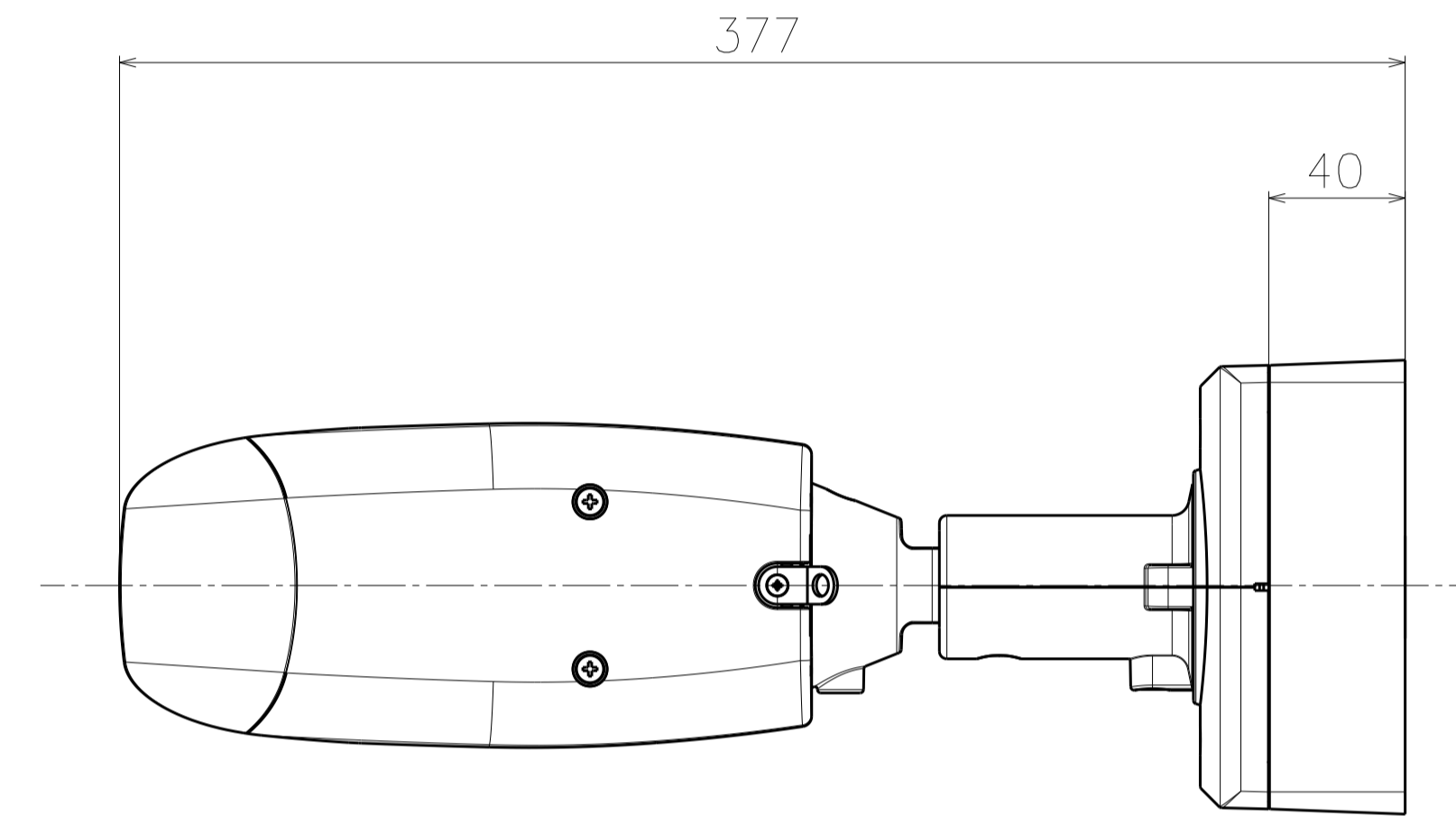
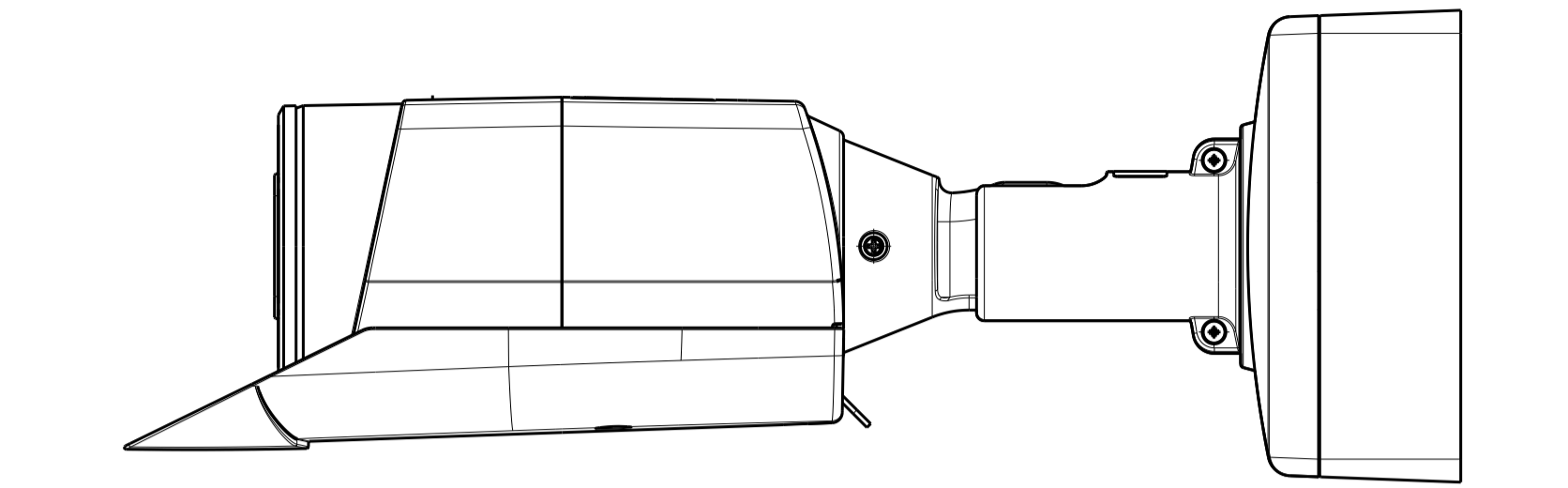
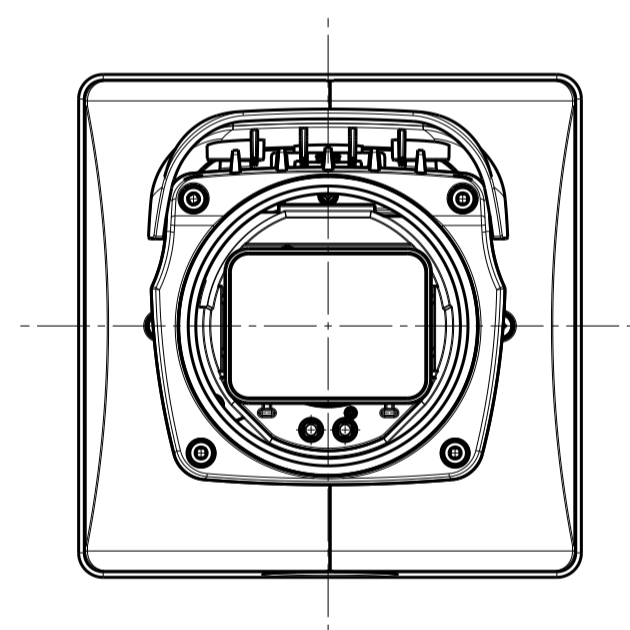

	投影面積/Projected area (With Adapter Box)
平面図/Top-view	0.031 (m ²)
側面図/Side-view	0.028 (m ²)

Weight : Approx. 2.2 kg {4.86 lbs}{(Except the Adapter Box)}

WV-S1552L

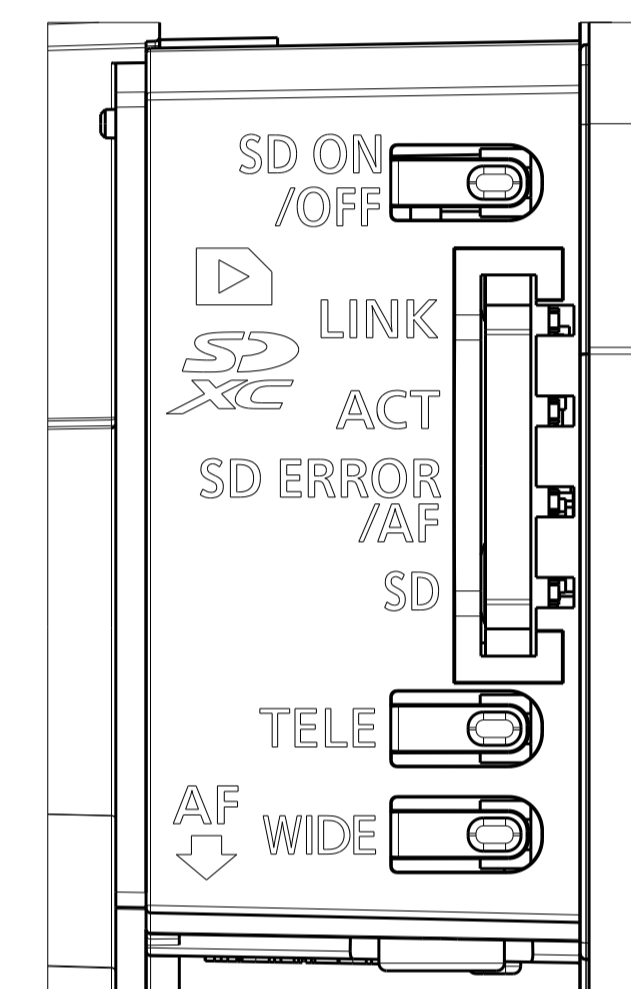
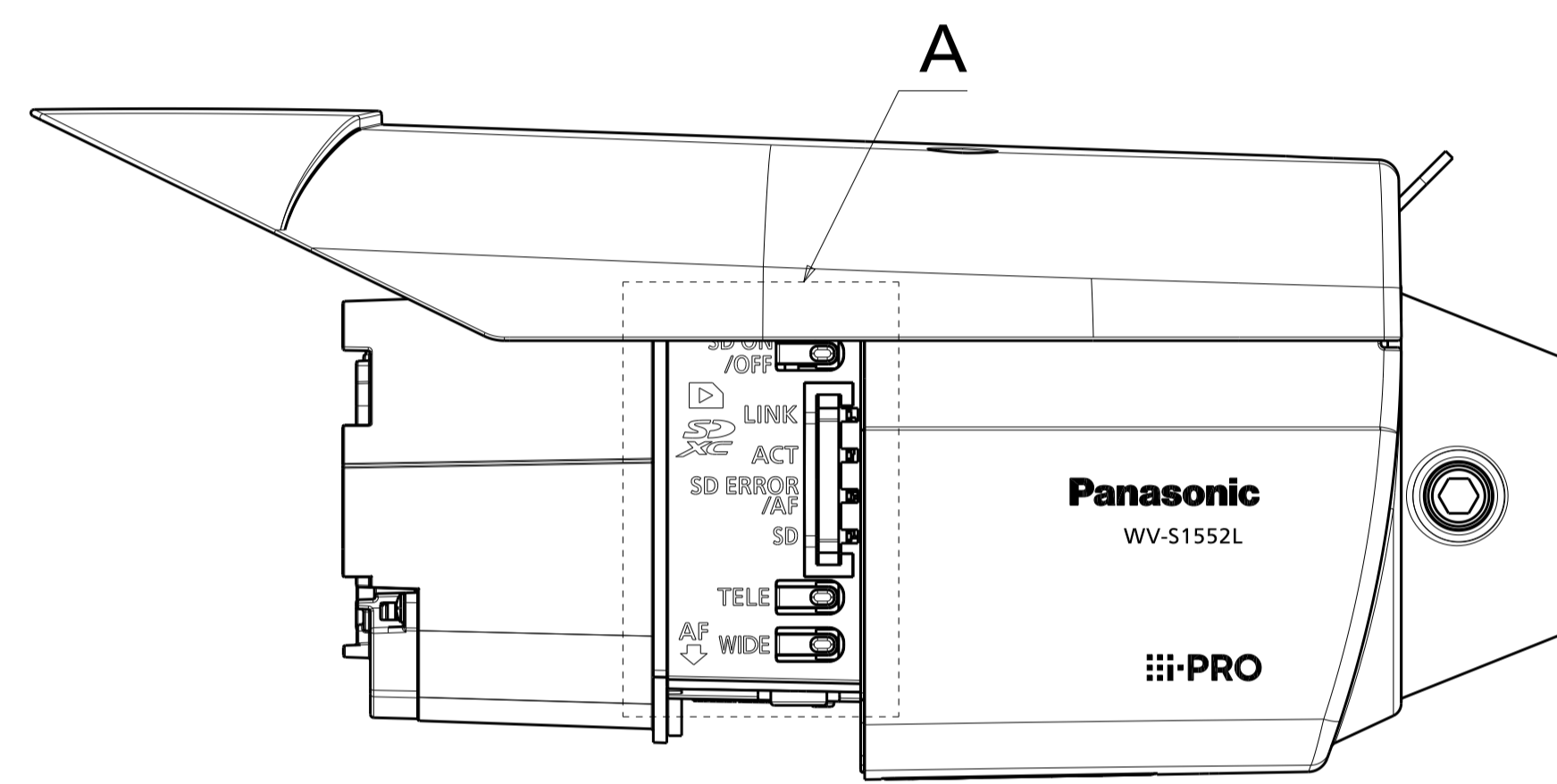
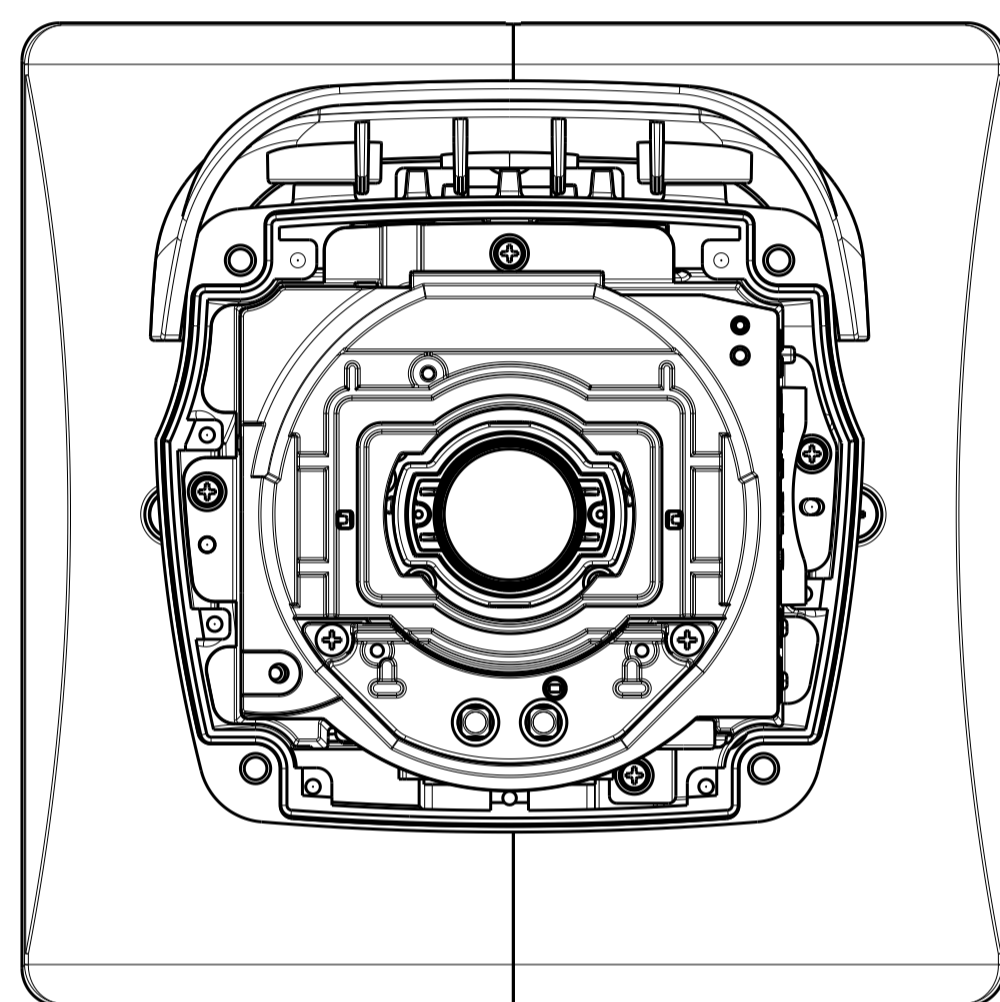

Detail A (2:1)

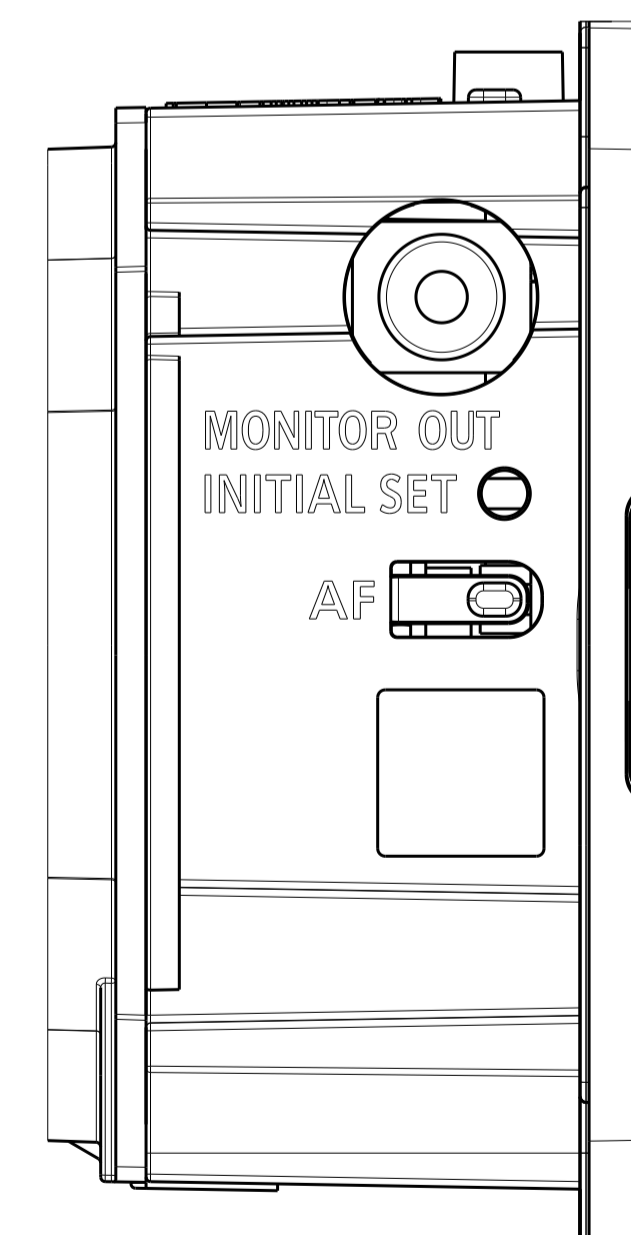
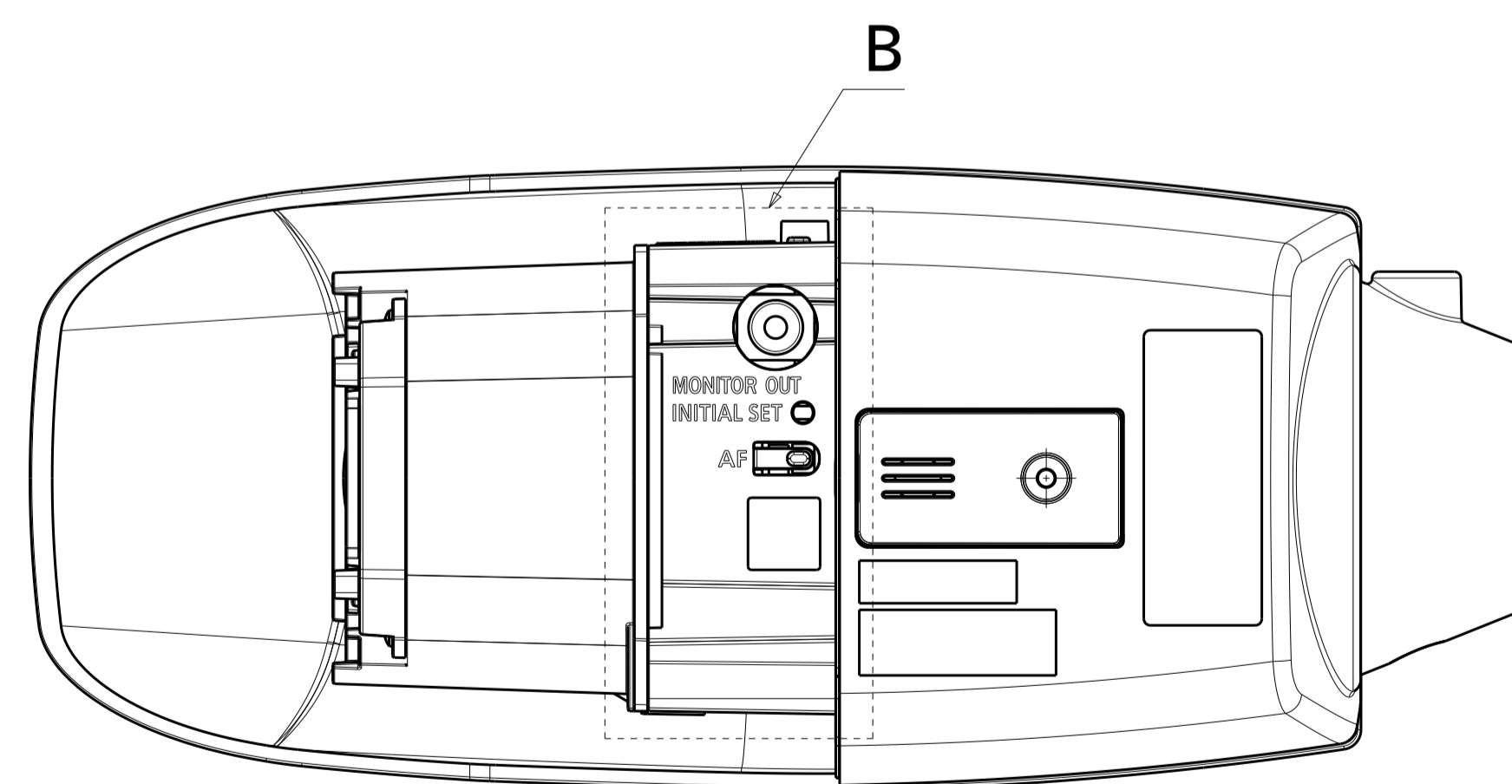

Detail B (2:1)

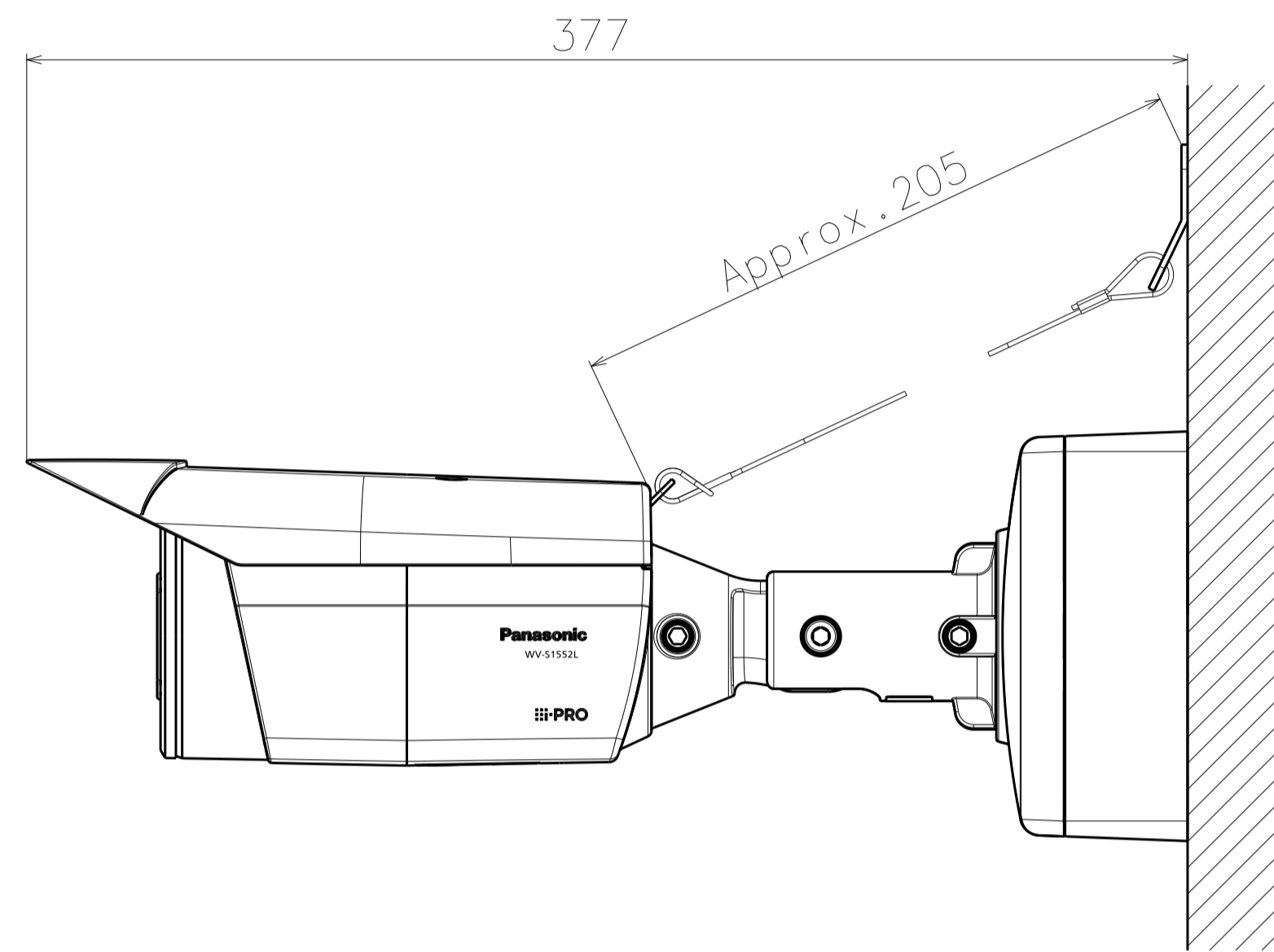

工事後の取付状態
Mounted state after construction

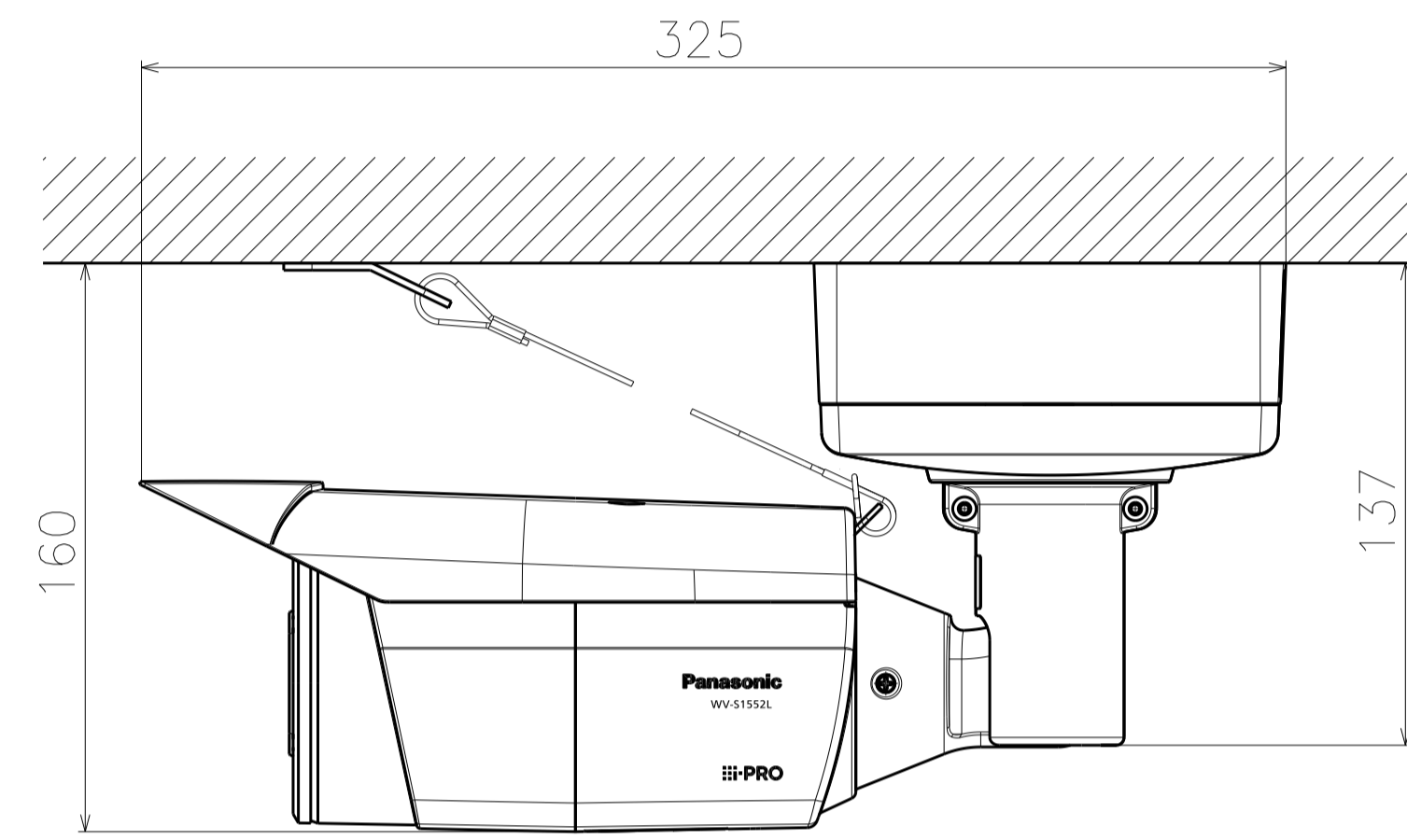
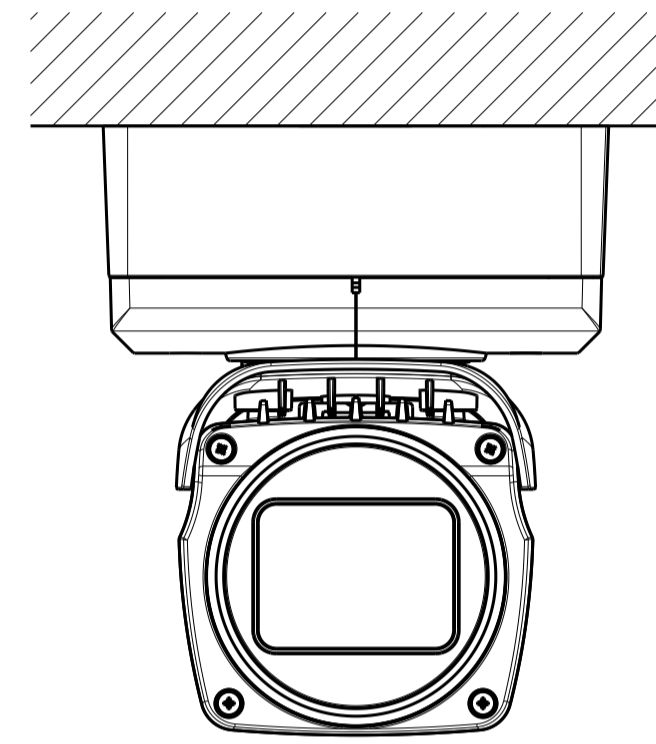

工事後の取付状態
Mounted state after construction

