

iii·PRO

Operating Instructions

System Controller

Model No. **WV-CU980**
WV-CU980/G

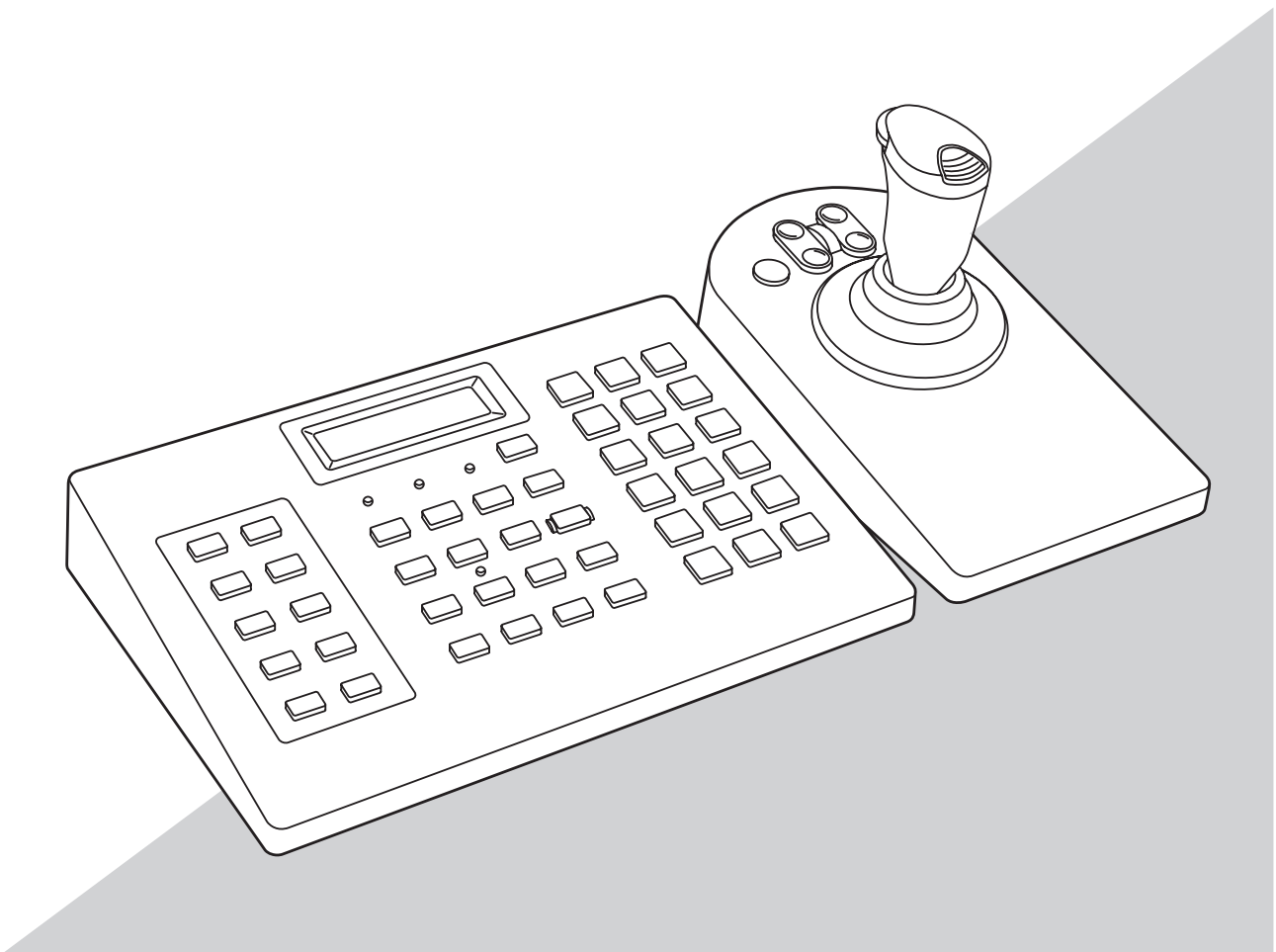

Before attempting to connect or operate this product,
please read these instructions carefully and save this manual for future use.

The model number is abbreviated in some descriptions in this manual.

Safety Information

WARNING:

- To prevent fire or electric shock hazard, do not expose this apparatus to rain or moisture.
- The apparatus should not be exposed to dripping or splashing and no objects filled with liquids, such as vases, should be placed on the apparatus.
- The mains plug or an appliance coupler shall remain readily operable.
- The connections should comply with local electrical code.
- This product has no power switch.
When turning off the power, disconnect the power supply from the 12 V DC power supply or remove a power cable.

CAUTION:

- The product is only intended for a connection to an Ethernet without routing to the outside plant.
- The AC adapter and power cord supplied in the accessories should be used only with this equipment. Do not use these with other equipment. In addition, never use an AC adapter and power cord from other equipment with this equipment.

For U.S.A. and Canada:
WV-CU980
For Europe and other countries:
WV-CU980/G

For U.S.A. and Canada:
This device complies with Part 15 of the FCC Rules and Innovation, Science and Economic Development Canada's licence-exempt RSS(s). Operation is subject to the following two conditions: (1) This device may not cause harmful interference, and (2) this device must accept any interference received, including interference that may cause undesired operation.

For U.S.A.
Supplier's Declaration of conformity
Trade Name: i-PRO
Model No. : WV-CU980
Responsible Party: i-PRO Americas Inc.
8550 Fallbrook Drive, Suite 200
Houston,
Texas 77064
Support Contact: 1-800-513-5417



Note: This equipment has been tested and found to comply with the limits for a Class A digital device, pursuant to Part 15 of the FCC Rules. These limits are designed to provide reasonable protection against harmful interference when the equipment is operated in a commercial environment. This equipment generates, uses, and can radiate radio frequency energy and, if not installed and used in accordance with the instruction manual, may cause harmful interference to radio communications. Operation of this equipment in a residential area is likely to cause harmful interference in which case the user will be required to correct the interference at his own expense.

FCC Caution:
Changes or modifications not expressly approved by the party responsible for compliance could void the user's authority to operate the equipment.

~ : Alternating current symbol

☐ : Direct current symbol

For U.S.A.

The model number and serial number of this product may be found on the surface of the unit.
You should note the model number and serial number of this unit in the space provided and retain this book as a permanent record of your purchase to aid identification in the event of theft.

Model No. _____
Serial No. _____

For Canada



CAN ICES-3(A)/NMB-3(A)

UL listed model No.:
WV-CU980

For use only with power supply PNLV6508

For U.K.

FOR YOUR SAFETY PLEASE READ THE FOLLOWING TEXT CAREFULLY.

This appliance is supplied with a moulded three pin mains plug for your safety and convenience.
A 5 amp fuse is fitted in this plug.
Should the fuse need to be replaced please ensure that the replacement fuse has a rating of 5 amp and that it is approved by ASTA or BSI to BS1362.
Check for the ASTA mark  or the BSI mark  on the body of the fuse.
If the plug contains a removable fuse cover you must ensure that it is refitted when the fuse is replaced.
If you lose the fuse cover the plug must not be used until a replacement cover is obtained.
A replacement fuse cover can be purchased from our dealer.

IF THE FITTED MOULDED PLUG IS UNSUITABLE FOR THE SOCKET OUTLET IN YOUR HOME THEN THE FUSE SHOULD BE REMOVED AND THE PLUG CUT OFF AND DISPOSED OF SAFELY. THERE IS A DANGER OF SEVERE ELECTRICAL SHOCK IF THE CUT OFF PLUG IS INSERTED INTO ANY 13 AMP SOCKET.

How to replace the fuse

The location of the differs according to the type of AC mains plug (figures A and B).
Confirm the AC mains plug fitted and follow the instructions below.
Illustrations may differ from actual AC mains plug.
Open the fuse cover with a screwdriver and replace the fuse and close or attach the fuse cover.

Figure A

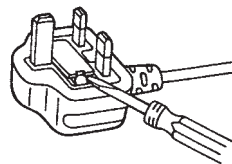
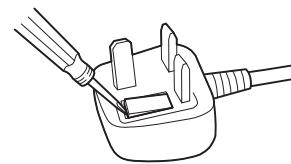

Figure B



Contents

Safety Information	2
Introduction	4
Preface	4
Features	4
Standard accessories	4
About the user manuals	4
Open Source Software.....	5
Copyright	5
Disclaimer of warranty	5
Network security	6
Limitation of liability	6
Precautions	7
Major operating controls and their functions	9
Before Operation	12
LCD Display Descriptions	12
On the notation of operations	13
Connection with the Joystick Unit	14
Connecting the AC adapter	14
Switching ON the Power.....	15
Switching OFF the Power	15
Flow of Basic Operations.....	15
First-time Setup	16
Normal operation	19
Main unit settings	20
On the settings menu.....	20
Flow of Settings Menu Screens	20
List of Settings Menus	21
Method of Using Settings Menus	22
Display / Buzzer Adjustment.....	23
Joystick settings	25
Network settings	27
Auto Login/Auto Logout Settings.....	31
Setting of the administrator.....	32
Operator Registration or Change.....	33
Deleting an operator	34
Changing the Function Level	34
Confirming the operator settings	36
Operation	37
Connecting with a PC	37
Operating the PC software.....	37
Maintenance	38
Joystick Unit Adjustment	38
Zoom wheel controller adjustment.....	41
All Reset	43
Troubleshooting	44
Specifications	46
Open Source Software	47

Introduction

Preface

The System Controllers WV-CU980 and WV-CU980/G (hereafter referred to as 'this equipment') are intended to be connected by Ethernet to a personal computer (hereafter referred to as 'PC') in which our company's Video Surveillance Software (hereafter referred to as 'PC software') has been installed, and to operate the PC software. This equipment can carry out selection of video image and PTZ operations of network cameras (hereafter referred to as 'camera') via the PC software.

In addition, it is also possible to record or play back the video image in a network disk recorder (hereafter referred to as 'recorder') via the PC software.

Features

Excellent Ease of Operation

A joystick that can be separated from the main unit is provided, and since smooth operations can be made by the grip portion of the joystick, it is possible to carry out the pan, tilt, and zoom operations of the camera via the PC software easily and with one hand. Also, a video play back button is provided which can be used via the PC software to play back the video recorded in the recorder.

Authentication function using ID and password

It is possible to set the (user level) operation rights for each user ID thereby preventing illegal operations.

Menu Functions

Various settings of this equipment can be made by button operations while viewing the information displayed on the display screen.

Standard accessories

Operating Instructions (this instruction)	1 pc.
Code Label*1	1 pc.
Power cord clamp	1 pc.
Power cord (WV-CU980)	1 pc.
Power cord (WV-CU980/G)	2 pcs.
AC Adopter	1 pc.
Transparent sheet*2	1 pc.

*1 This may sometimes be necessary for network management. Please be sure not to lose this.

*2 When pressing the name sheet provided separately, remove the original sheet, and use this sheet after removing the protective films on both sides of this sheet.

(Used when the functions of the PC software are different from the button indications of this unit.)

About the user manuals

Refer to our support website (https://i-pro.com/global/en/surveillance/training_support/support/technical_information) for latest information about the functions to be added or changed by firmware upgrade.

Note:

- The external appearance in the document may differ from the actual product within no influence range on operation due to improvement of the product.

Open Source Software

- This product contains software licensed under BSD. Refer to page 47 in this manual about the license.
- Please note that we shall not respond to any inquiries regarding the source code, and so on.

Copyright

Except for open source software licensed under BSD, distributing, copying, disassembling, reverse compiling and reverse engineering of the software provided with this product are all expressly prohibited. In addition, exporting any software provided with this product violating export laws is prohibited.

Disclaimer of warranty

IN NO EVENT SHALL i-PRO Co., Ltd. BE LIABLE TO ANY PARTY OR ANY PERSON, EXCEPT FOR REPLACEMENT OR REASONABLE MAINTENANCE OF THE PRODUCT, FOR THE CASES INCLUDING BUT NOT LIMITED TO BELOW:

- (1) ANY LOSS OR DAMAGE, INCLUDING WITHOUT LIMITATION, DIRECT OR INDIRECT, SPECIAL, CONSEQUENTIAL OR EXEMPLARY, ARISING OUT OF OR RELATING TO THE PRODUCT;
- (2) ANY INCONVENIENCE, LOSS, OR DAMAGE CAUSED BY INAPPROPRIATE USE OR NEGLIGENT OPERATION OF THE USER;
- (3) ALL MALFUNCTIONS OR TROUBLES FROM UNAUTHORIZED DISASSEMBLY, REPAIR, OR MODIFICATION OF THE PRODUCT BY THE USER, REGARDLESS OF THE CAUSE OF THE MALFUNCTION OR TROUBLE;
- (4) INCONVENIENCE OR ANY LOSS ARISING WHEN IMAGES ARE NOT DISPLAYED, DUE TO ANY REASON OR CAUSE INCLUDING ANY FAILURE OR PROBLEM OF THE PRODUCT;
- (5) ANY PROBLEM, CONSEQUENTIAL INCONVENIENCE, OR LOSS OR DAMAGE, ARISING OUT OF THE SYSTEM COMBINED WITH THIRD PARTY DEVICES;
- (6) ANY CLAIM OR ACTION FOR DAMAGES BROUGHT BY ANY PERSON OR ORGANIZATION AS A PHOTOGRAPHED SUBJECT DUE TO VIOLATION OF PRIVACY CONCERNING A SURVEILLANCE CAMERA'S PICTURE OR SAVED DATA, FOR SOME REASON (INCLUDING USE WHEN USER AUTHENTICATION ON THE AUTHENTICATION SETTING SCREEN IS SET TO OFF), BECOMING PUBLIC OR BEING USED FOR ANY PURPOSE;
- (7) LOSS OF REGISTERED DATA CAUSED BY ANY FAILURE (INCLUDING INITIALIZATION OF THE PRODUCT DUE TO FORGOTTEN AUTHENTICATION INFORMATION SUCH AS A USER NAME AND PASSWORD).

Network security

As you will use this unit connected to a network, your attention is called to the following security risks.

- ① Leakage or theft of information through this unit
- ② Use of this unit for illegal operations by persons with malicious intent
- ③ Interference with or stoppage of this unit by persons with malicious intent

It is your responsibility to take precautions such as those described below to protect yourself against the above network security risks.

- Use this unit in a network secured by a firewall, etc.
- If this unit is connected to a network that includes PCs, make sure that the system is not infected by computer viruses or other malicious entities (using a regularly updated anti-virus program, anti-spyware program, etc.).
- Protect your network against unauthorized access by restricting users to those who log in with an authorized user name and password set by using user authentication.
- Change the administrator password periodically. Keep the authentication information (your user name and password) in a safe place free from public view.

Limitation of liability

THIS PUBLICATION IS PROVIDED "AS IS" WITHOUT WARRANTY OF ANY KIND, EITHER EXPRESS OR IMPLIED, INCLUDING BUT NOT LIMITED TO, THE IMPLIED WARRANTIES OF MERCHANTABILITY, FITNESS FOR ANY PARTICULAR PURPOSE, OR NON-INFRINGEMENT OF THE THIRD PARTY'S RIGHT.

THIS PUBLICATION COULD INCLUDE TECHNICAL INACCURACIES OR TYPOGRAPHICAL ERRORS.

CHANGES ARE ADDED TO THE INFORMATION HEREIN, AT ANY TIME, FOR THE IMPROVEMENTS OF THIS PUBLICATION AND/OR THE CORRESPONDING PRODUCT(S).

Precautions

Refer installation work to the dealer.

Installation work requires technique and experience. Failure to observe this may cause fire, electric shock, injury, or damage to the product.

- Be sure to consult the dealer.

Do not disassemble nor alter this product.

Failure to observe this may cause fire or electric shock.

- Ask your dealer for inspection and repair.

Do not insert any foreign objects.

Do not allow any foreign object or liquid such as water, a metallic part, etc. to enter since it may cause fire or electric shock.

- If it happens, disconnect the power plug from the electric outlet immediately and contact your dealer.

Stop the operation immediately when something is wrong with this product.

When smoke goes up from the product or the smell of smoke comes from the product, continued use will result in fire, injury, or damage to the product.

- Turn off the power of this product immediately, and then contact your dealer.

Avoid placing receptacles that contain liquids such as water on/near this product.

If liquid spills onto this product, it may cause fire or an electric shock.

- If it happens, disconnect the power plug from the electric outlet immediately and contact your dealer.

Clean the power plug periodically to keep it dust free.

Dust can cause the insulation to be damaged and cause a fire.

- When cleaning, disconnect the power plug and wipe with a clean dry cloth.

Do not touch this product, power cord and connected cables when thunder is heard.

Failure to observe this may cause electric shock.

Do not connect/disconnect the power plug with wet hands.

Failure to observe this may cause electric shock.

Avoid doing anything that can damage the power cord/plug.

Do not damage, modify, forcefully bend, twist, stretch or bundle the power cord, and do not put a heavy thing on the power cord.

Using a damaged power cord can cause electric shock, short circuit, fire, etc.

- Contact your dealer for repair of the power cord and plug.

Do not engage in work related to the installation and wiring while the power is on.

Failure to observe this may cause fire or electric shock.

Hold the power plug to disconnect the power cord.

Do not pull the power cord since it can cause fire, electric shock, etc.

Connect the power plug firmly.

If the power plug is not connected firmly, it can cause fire, electric shock, etc.

- Do not use the damaged power cord and loose electric outlets.

Do not connect to outlets or wiring device if their ratings are beyond the specified rating.

If the rating goes over the specified rating such by putting many loads on one electric outlet, it can cause generation of heat resulting in fire.

Do not strike or give a strong shock to this product

Failure to observe this may cause fire or electric shock.

Avoid placing this product in locations which are subject to humidity and dust.

Failure to observe this may cause fire or electric shock.

The product is only intended for a connection to an ethernet without routing to the outside plant.

Precautions (continued)

Precautions for use

Power source

The input power source for this product is 100 V - 240 V AC 50 Hz / 60 Hz.

Do not connect to an outlet that provides the power to equipment that requires a measurable amount of power (such as a copy machine, air conditioner, etc.). Avoid placing this product in locations subject to water contact.

* The provided power cord(s) is (are) dedicated to use with this product. Do not use with any other device. Also, do not use any other power cord with this product.

To cut the power supply

This product has no power switch. To cut the power supply, unplug the power plug of the product from the AC outlet. Install the AC outlet near this product to make it easy to plug in and unplug the power cord. If the power cord cannot be unplugged easily due to installation conditions, connect the power cord to an AC outlet via a distribution board circuit breaker with a cut-off capacity.

Ambient operating temperature

Use this product at temperatures between 0 °C to 50 °C {41 °F to 113 °F}. Failure to do so may damage the internal parts or cause malfunction.

Prevent condensation from forming

If this happens, it can cause malfunction.

Leave it switched off for around 2 hours in the following cases.

- When this product is placed in an extremely humid place.
- When this product is placed in a room where a heater has just been turned on.
- When this product is moved from an air-conditioned room to a humid and high-temperature room.

Cleaning

- Turn the power off, and then use a soft cloth to clean this product.
- Do not use strong or abrasive detergents when cleaning the body.
- When using a chemical cloth for cleaning, read the precautions provided with the chemical cloth product.

Indication label







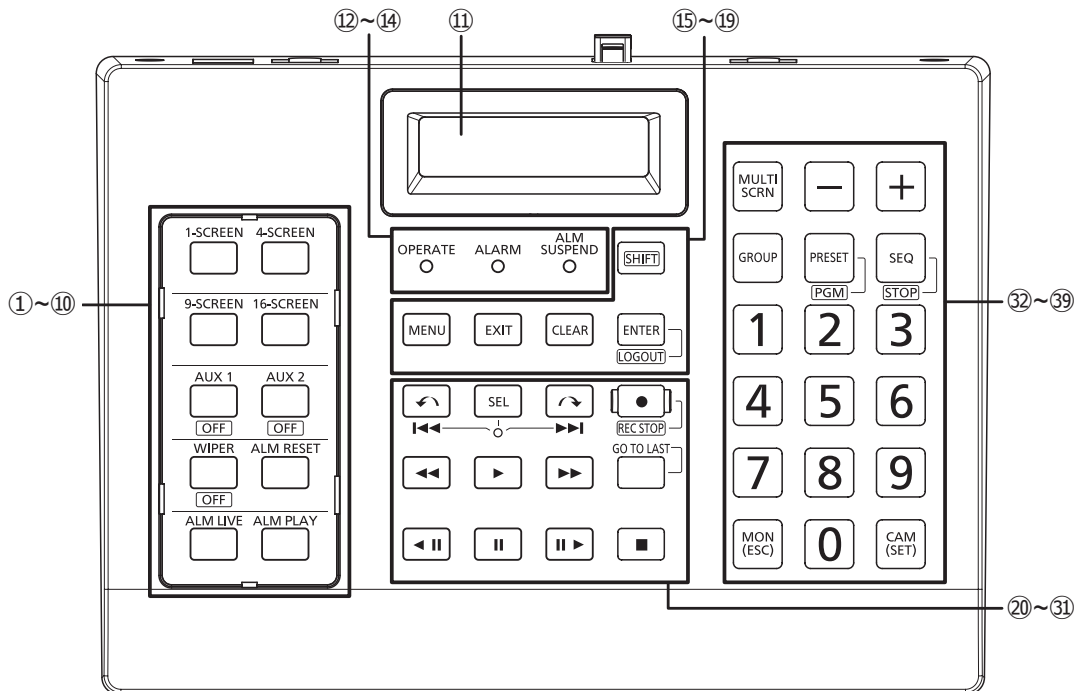





Refer to the indication label placed on the bottom of this product for the equipment classification and power source, etc.

Major operating controls and their functions

Main Unit - Front Panel

























Note: Available functions and display indications differ depending on the connected PC software. The following descriptions are for the example of operating a recorder or camera via a WV-ASM300 (sold separately) connected to this equipment.

- | | |
|--|---|
| <p>① 1-SCREEN
 [1-SCREEN] button
The operation monitor is changed to the 1-screen mode.</p> <p>② 4-SCREEN
 [4-SCREEN] button
The operation monitor is changed to the 4-screen mode.</p> <p>③ 9-SCREEN
 [9-SCREEN] button
The operation monitor is changed to the 9-screen mode.</p> <p>④ 16-SCREEN
 [16-SCREEN] button
The operation monitor is changed to the 16-screen mode.</p> <p>⑤ AUX 1
 [AUX 1 / OFF] button
Turns AUX1 ON.
AUX1 is made OFF (if [SHIFT] has been pressed).</p> <p>⑥ AUX 2
 [AUX 2 / OFF] button
Turns AUX2 ON.
AUX2 is made OFF (if [SHIFT] has been pressed).</p> <p>⑦ WIPER
 [WIPER / OFF] button
Operates the wiper
Stops the wiper (if [SHIFT] has been pressed).</p> <p>⑧ ALM RESET
 [ALM RESET] button
Used for resetting an alarm.</p> <p>⑨ ALM LIVE
 [ALM LIVE] button
Used for displaying alarm live video.</p> | <p>⑩ ALM PLAY
 [ALM PLAY] button
Used for playing alarm video.</p> <p>⑪ LCD Display Displays the login screen, the main unit settings screens, the operation screens for maintenance, etc.</p> <p>⑫ OPERATE
 [OPERATE] indicator
Lights up when the power has been switched ON.</p> <p>⑬ ALARM
 [ALARM] indicator^{*1}
Flashes when an alarm is generated.
Lights up continuously when an alarm is reset automatically.</p> <p>⑭ ALM SUSPEND
 [ALARM SUSPEND] indicator^{*1}
Lights up when an alarm is suspended.</p> <p>⑮ [SHIFT] button
Used for switching to the function indicated on the bottom part of the button.</p> <p>⑯ [MENU] button
Used for displaying the list of menu functions.</p> <p>⑰ [EXIT] button
Used while making a setting for returning without confirming the setting that has just been made.</p> <p>⑱ [CLEAR] button
Used for clearing the value set using the numeric buttons.</p> |
|--|---|

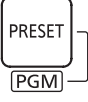
*1 Not yet supported. (As of November 2019)

Major operating controls and their functions (continued)

- 19  **[ENTER/LOGOUT] button**
Used for confirming in the PC software (same as the operation of pressing the [Enter] key on the PC keyboard).
Used for logging out of this equipment (if [SHIFT] has been pressed).
- 20  **[REV SKIP / PREV RECORD] button^{*1}**
Used for making a reverse skip while playing back from the recorder.
Used for going to the Prev Record while playing back from the recorder (when put in the SEL state (SEL indicator blinking) by pressing ).
- 21  **[SEL] button, [SEL] indicator**
Used for selecting the operation of the SKIP / NEXT RECORD (REV SKIP / PREV RECORD) button during recorder playback.
 When this [SEL] button is pressed, the equipment goes into the SEL state and the [SEL] indicator blinks, and when this [SEL] button is pressed again, the SEL state is released, and the [SEL] indicator goes off.
- 22  **[SKIP / NEXT RECORD] button^{*1}**
Used for making a skip while playing back from the recorder.
Used for going to the Next Record while playing back from the recorder when in the SEL state (SEL indicator blinking) due to pressing ).
- 23  **[REC / REC STOP] button^{*2}**
Used for starting a video recording by the recorder.
Used for stopping the video recording by the recorder (if [SHIFT] has been pressed).
- 24  **[REW] button**
Used for rewinding and playing back when playing back from the recorder.
- 25  **[PLAY] button**
Used for starting the video playback by the recorder.
- 26  **[FF] button**
Used for fast forwarding and playing back when playing back from the recorder.
- 27  **[GO TO LAST] button**
Used for displaying the latest playback image of the recorder.
- 28  **[PREV IMAGE] button**
Used for rewinding and playing back when playing back from the recorder.
This changes the screen or increases or decreases the set value (when making the settings on the main unit).
- 29  **[PAUSE] button**
Used for pausing the video playback by the recorder.
- 30  **[NEXT IMAGE] button**
Used for playing back the next image when the playing back from the recorder has been paused.
This changes the screen or increases or decreases the set value (when making the settings on the main unit).
- 31  **[STOP] button**
Used for stopping the video playback by the recorder.
- 32  **[MULTI SCRNR] button**
Used for simultaneously displaying in a single monitor multiple camera images by dividing the screen.
- 33  **[-] button / [+] button**
Used for selecting the image by increasing or decreasing the camera number.
Increases or decreases the numerical value in some of the settings (while setting the main unit).
- 34  **[GROUP] button**
Used for inputting the group number.
- 35  **[PRESET / PGM] button**
Used for calling a preset position or the home position of a camera.
Used for programming a preset position of a camera (if [SHIFT] has been pressed).
- 36  **[SEQ / STOP] button**
Used for starting a sequence operation by inputting a sequence number.
Used for stopping the sequence operation (if [SHIFT] has been pressed).
- 37  **[0] to [9] buttons (numeric buttons)**
Used for inputting the camera number, the group number, the sequence number, etc.
- 38  **[MON (ESC)] button**
Used while making a setting for returning without confirming the setting that has just been made.
Used for canceling in the PC software (same as the operation of pressing the [ESC] key on the PC keyboard).
- 39  **[CAM (SET)] button**
Used for selecting a camera.
While making a setting, used for confirming or selecting a setting item.

*1 For details of the function, refer to instruction manual of WV-ASM300.

*2 This function does not support the recorders of the NV series and the NX series. (As of November 2019)

Major operating controls and their functions (continued)

Main Unit - Rear Panel

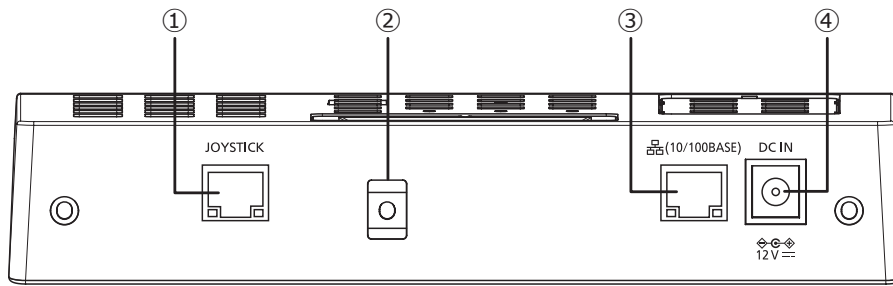

① Joystick connector [JOYSTICK]

Connect a Joystick.

② Clamp mount

Fix the DC cable of the AC adapter using a cable clamp (provided as an accessory). (⇨ Page 14)

③ RJ45 Network terminal [10/100BASE]

Connect to a 10BASE-T or 100BASE-TX network, thereby connecting the main unit with a PC in which the PC software has been installed.

The access indicator (green) blinks during access.

The link indicator (orange) lights up when a link has been established.

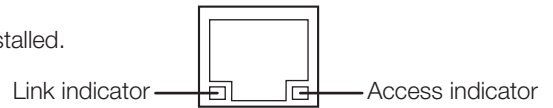

④ Power supply terminal [DC IN]

Connect the DC plug of the supplied AC adapter.

Insert the DC plug fully inside so that it does not become loose or detached.

Joystick unit

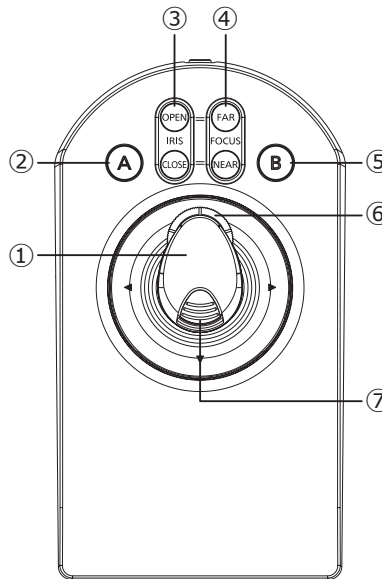

①



Joystick

Used for panning or tilting a camera. Can also be used for the cursor movement in some setting items.

②



[A] Button

Used for carrying out a function^{*1} that has been allocated in advance.

③



[IRIS OPEN / CLOSE] buttons

Used for adjusting the aperture of a camera.

④



[FOCUS FAR / NEAR] buttons

Used for adjusting the aperture of a camera.

⑤



[B] Button

Used for carrying out a function^{*2} that has been allocated in advance.

⑥



Zoom wheel controller

Used for adjusting the zooming of a camera.

⑦



Top button

Used for carrying out a function^{*3} that has been allocated in advance.

*1 Start auto mode

*2 End auto mode

*3 Start auto tracking or Auto focus execution

Before Operation

LCD Display Descriptions

Operation screen

The display screens during operations differ depending on the connected PC software. For details, refer to the instruction manual of the PC software to be connected.

Menu Function Selection Screen



① Function number

The function number of the menu being selected is displayed.

② Function name

The name of selected menu function is displayed. For details, see "List of Settings Menus" (☞ Page 21).

On blinking display

In this manual, a blinking display is indicated by enclosing in .

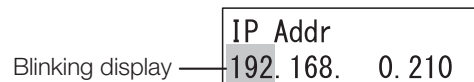

Error messages on the display

Display of "Invalid"

When you have input a wrong user ID or password at the time of logging in, the word "Invalid" blinks on the display. The display of "Invalid" automatically goes off after a few seconds.

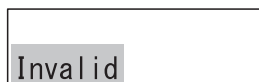

Display of "Set 8 digits num"

A blinking display is shown of "Set 8 digits num" when any input other than 8 numeric digits is made at the time of registering the administrator ID or password. The display of "Set 8 digits num" is automatically stopped after a few seconds.



Display of "Out Of Range"

When a mistaken input is made of a value other than 0 to 255, at the time of registering the IP address, etc., in the network settings, a blinking display is shown of the message "Out of Range".

The display of "Out of Range" automatically goes off after a few seconds.

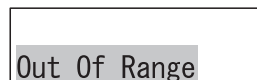

Display of "Passwd Mismatch"

A blinking display is shown of "Passwd Mismatch" when the password input for the second time is different from the password input for the first time at the time of registering the administrator password.

The display of "Passwd Mismatch" automatically goes off after a few seconds.



Display of "Prohibited"

When an attempt is made to carry out an operation that is restricted by the user administration function (function level) of this equipment, a blinking display is shown of the message "Prohibited". After a few seconds, the display of "Prohibited" goes off automatically and the display returns to the operation screen.

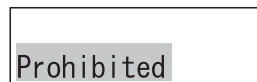

On the notation of operations

The icons (illustrations) of the buttons or joystick used in the settings and operations of this equipment are described below.

(1) Joystick

Illustration of joystick	Notation in this manual	Description of operations
		Move the joystick in any one of the directions up, down ^{*1} , left, or right.
		Move the joystick up or down ^{*1} .
		Move the joystick left or right.
		Move the joystick to the left.
		Move the joystick to the right.
		Press the top button of the joystick.
		Rotate the zoom wheel controller either to the left or to the right.
		Rotate the zoom wheel controller to the left (in the counterclockwise direction).
		Rotate the zoom wheel controller to the right (in the clockwise direction).

*1 Interpret "up - down" as "front - back" when the joystick is being operated independently and the camera is not being operated.

(2) About the buttons / indicators

Regarding the individual buttons and indicators, the respective shapes of the buttons / indicators have been made into icons.

Regarding the buttons whose functions change when the **SHIFT** (SHIFT) button is pressed, both functions have been indicated. The description of operations when the button is pressed simultaneously with **SHIFT** is for the case when the bottom function indication (with square border) has been pressed.

Simultaneous operation of multiple buttons is indicated by "+".

Regarding the buttons whose functions change in the SEL state (the SEL indicator is blinking) when the **SEL** (SEL) button is pressed, both functions have been indicated. In the SEL selected state, the function indicated on the bottom part of the button is executed when the button is pressed.

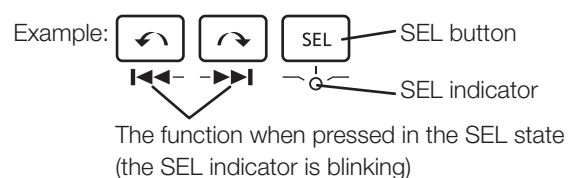
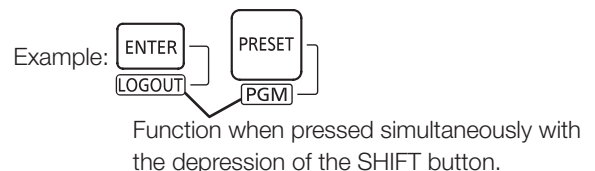
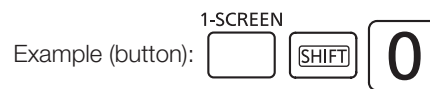

Connection with the Joystick Unit

Connect the cable of the joystick unit to the joystick connector terminals [JOYSTICK] at the back of the main unit.

Important:

- A “Serial number label” is affixed to the bottom surface of the main unit and of the joystick unit.
Connect a main unit and a joystick unit having the same number in the respective “Serial number labels”.

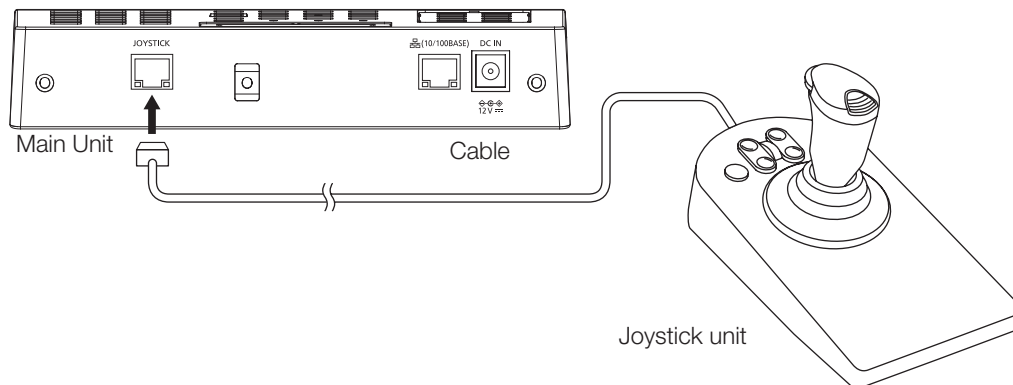

Connecting the AC adapter

Connect the power supply cord (accessory) to the AC adapter (accessory), and connect the DC plug of the AC adapter to the power supply terminals at the back of the main unit.

Important:

- Insert the DC plug fully inside so that it does not become loose or gets detached.
- In order to prevent the DC plug from getting detached, securely fix the DC cable using the cable clamp provided as an accessory.

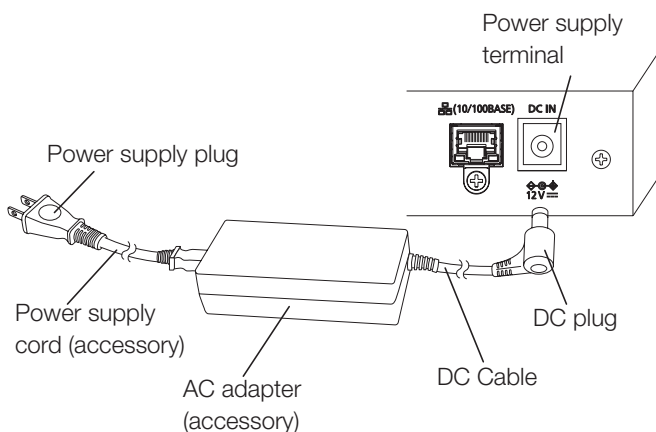

Method of preventing DC plug from getting detached

- ① Pass the cable clamp (accessory) through the upper hole of the clamp mount.
- ② Provisionally fix the DC cable using the cable clamp.
- ③ Fix the DC cable by tightening the cable clamp at about 8 cm to 9 cm from the DC plug. If necessary, cut the excess portion of the cable clamp.

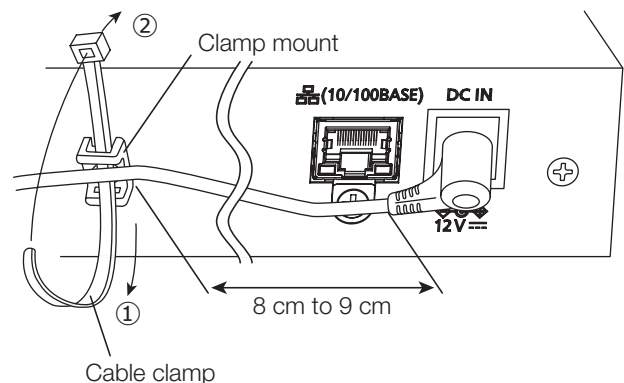

Switching ON the Power

1 Insert the power supply plug of the AC adapter into a power socket whose rating as follows.

WV-CU980: 120 V AC, 60 Hz

WV-CU980/G: 220 V – 240 V AC, 50 Hz / 60 Hz

→The [Operation] indicator lights up, the software version and the login awaiting screen are displayed successively on the display.

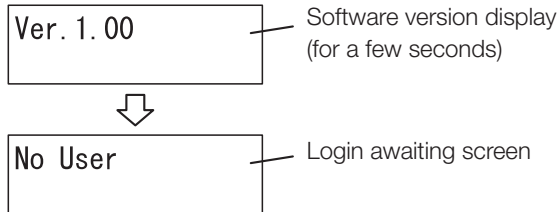

2 When using the main unit for the first time, or when “All Reset” is carried out, the initial registration start screen is displayed after the software version is displayed

Initial Setup
Start?

Carry out “Initial registration” of “First-time Setup”.
(☞ Page 16)

Switching OFF the Power

1 Log out

For the method of operation, see “Logging out” of “First-time Setup” (☞ Page 18)

2 Remove the power supply plug from the power supply socket

→ When the power supply goes OFF, the [Operation] indicator goes OFF.

Flow of Basic Operations

First-time Setup

This is the setting required after the settings of the main unit are reset to the initial state when using the main unit for the first time, or when “All Reset” (☞ Page 43) is carried out.

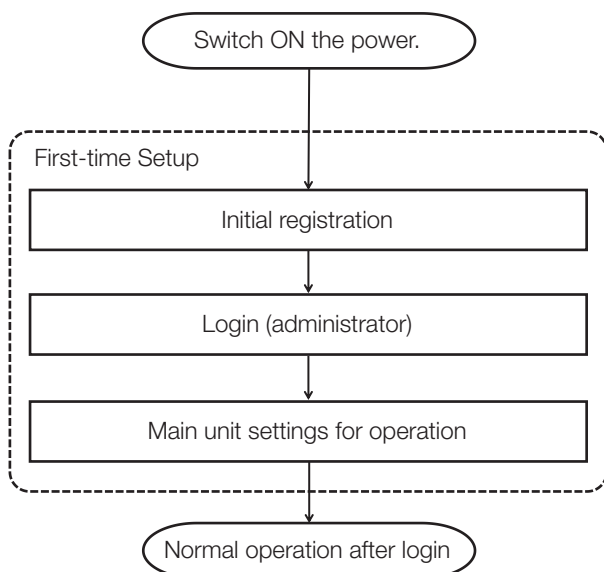

Normal operation

These are the operations for normal operation of this equipment.

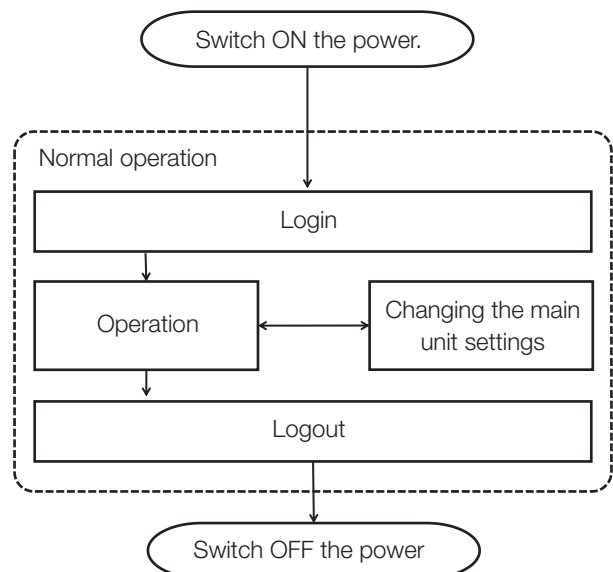

First-time Setup

This is the setup required after the settings of the main unit are reset to the initial state when using the main unit for the first time, or when "All Reset" (☞ Page 43) is carried out.





Initial registration

Register the administrator ID and password, and the key for communication (☞ Page 30) with the PC software to be connected.

Important:

- In order to ensure security, set an ID, password, and key for communication that cannot easily be guessed by a third party.
- Take care not to forget the ID, password, and key for communication that has been set, and manage it appropriately away from the eyes of a third party.
- Change the passwords periodically.

Note:

- The administrator ID, password, and the key for communication are numbers with a fixed length of 8 digits.
- When correcting the input of the numbers of the administrator ID, password, and the key for communication, press  to erase the number that was input.
- If a wrong setting (other than 8 numeric digits) is made and  is pressed, "Set 8 digits num" is displayed for a few seconds, and the display returns to the previous input screen. Enter an 8-digit number.
- In each input screen, the display returns to the immediately previous screen when  or  is pressed.

1 When the power supply is switched ON, the initial registration start screen is displayed



2 Press

The administrator ID setting screen is displayed.



3 Enter the administrator ID using the numeric buttons

The administrator ID can be set within the values "00000000" to "99999999" (8 numeric digits).



4 Press

The administrator password input screen is displayed.



5 Enter the administrator password using the numeric buttons

The administrator password can be set within the values "00000000" to "99999999" (8 numeric digits).

The digits of the password that have been input are displayed as asterisks "*".



6 Press

The message "Passwd Re-enter" is displayed for a few seconds, and the administrator password input screen is displayed again.



7 Enter again the administrator password that was input in Step 5



Before Operation (continued)

8 Press

The screen for inputting the key for communication with the connected destination is displayed.

When the administrator passwords input in Step 5 and Step 7 are different from each other, the error message "Passwd Mismatch" is displayed for a few seconds, and then the display returns to the screen of Step 2.

Communicat Key
[REDACTED]

9 Enter the key for communication with the connected destination using the numeric buttons

The key for communication with the connected destination can be set within the range of values "00000000" to "99999999" (8 numeric digits).

Communicat Key
12345678

Login (administrator)

Log in using the administrator ID and password registered at the time of initial registration.

1 Once the initial registration is completed, the login awaiting screen is displayed

No User

2 Press

The user ID input screen is displayed.

User ID [REDACTED]

Note:

- It is also possible to input the user ID immediately using the numeric buttons after Step 1.

3 Enter the user ID using the numeric buttons

Input here the administrator ID that was registered as the user ID at the time of initial registration.

The user ID that has been input is displayed.

User ID 12345678

10 Press

The settings confirmation screen is displayed.

Initial Setup
Set?

11 Press

The settings registration screen is displayed for a few seconds.

After that, the display changes to the Login awaiting screen.

Initial Setup
Memory

4 Press

The password input screen is displayed.

User ID 12345678
Passwd [REDACTED]

5 Enter the password using the numeric buttons

Input here the administrator password that was registered as the password at the time of initial registration.

The digits of the password that have been input are displayed as asterisks "*".

User ID 12345678
Passwd *****

6 Press

The login successful message "Login OK" is displayed for a few seconds and the unit goes into the logged-in state.

When you have input a wrong user ID or password, blinking display is made of the message "Invalid" for a few seconds, and then the display returns to the login awaiting screen.

Login OK

Before Operation (continued)

■ The PC Software Connected Screen is displayed

When the connection with the PC software is completed, the display changes to the operation screen.

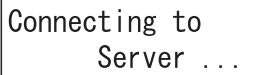

Connecting to
Server ...

Here, since the main unit settings have not yet been made, the "Connecting to Server ..." screen continues to be displayed.

Main unit settings for operation

The Main unit settings necessary for operation are made here.

- Display/Buzzer Adjustment
- Joystick Settings
- Network Settings
- Auto Login/Auto Logout Settings
- Operator Registration or Change
- Changing Function Level



Operation procedure

The main unit settings are made using the menu functions. For details, see "Method of Using the Settings Menus" (☞ Page 22).

Logout

To log out of this system.

Operation procedure

■ In the logged-in state, press **SHIFT** +  

The logout message "Logout" is displayed for a few seconds and the display goes into the login awaiting screen.



Logout → No User

Note:

- It is not possible to log out when the menu functions are being used. Log out after ending the menu functions.
-

Normal operation

Start normal operation.

Before starting operation, start the PC software to be connected and put it in a state in which it can be operated from this equipment. For details, refer to the instruction manual of the PC software to be connected.

Also, refer to "Connecting with a PC" (☞ Page 37) regarding connecting to the PC.

Login

Log in using the user ID and password of the operator registered during the First-time Setup (or during a change of the main unit settings during operation).

Operation procedure

For details, see "Login (administrator)" in "First-time Setup" (☞ Page 17). The user ID and password input here are the user ID and password of the operator who is logging in (or the administrator ID and password).

When auto login has been set

■ When the power is switched ON, the message "Auto Login" and the User ID of the logged-in operator (or the administrator ID) are displayed for a few seconds, and the equipment goes into the logged-in state

Auto Login User ID 12345678

Operation

When logging in has succeeded and the connection with the PC software is established, the display changes to the operation screen.

The connected PC software is operated using the buttons on the equipment and also using the joystick.

Operation procedure

For details, refer to the instruction manual of the PC software.

Changing the main unit settings

The Main unit settings are changed as needed for the operations.

When having logged in using the user ID and password of an operator, in some of the settings, it will be necessary to input the administrator ID and password before entering the settings screen.

Operation procedure

The main unit settings are made using the menu functions. For details, see "Method of Using the Settings Menu" (☞ Page 22).

Logout

To log out of this system.

Operation procedure

For details, see "Logout" in "First-time Setup" (☞ Page 18).

Note:

- It is not possible to log out when the menu functions are being used. Log out after ending the menu functions.
-

Main unit settings

On the settings menu

Various settings can be made in this equipment using the settings menu. The settings menu is displayed on the display screen, and the settings are made by operating the buttons or the joystick.

Flow of Settings Menu Screens

The setting menu screen is displayed when **MENU** is pressed on the operation screen. The display returns to the operation screen if either **EXIT** or **MON (ESC)** is pressed on the setting menu screen, or if no operation is made for 60 seconds.

The transitions of the screen are given below.

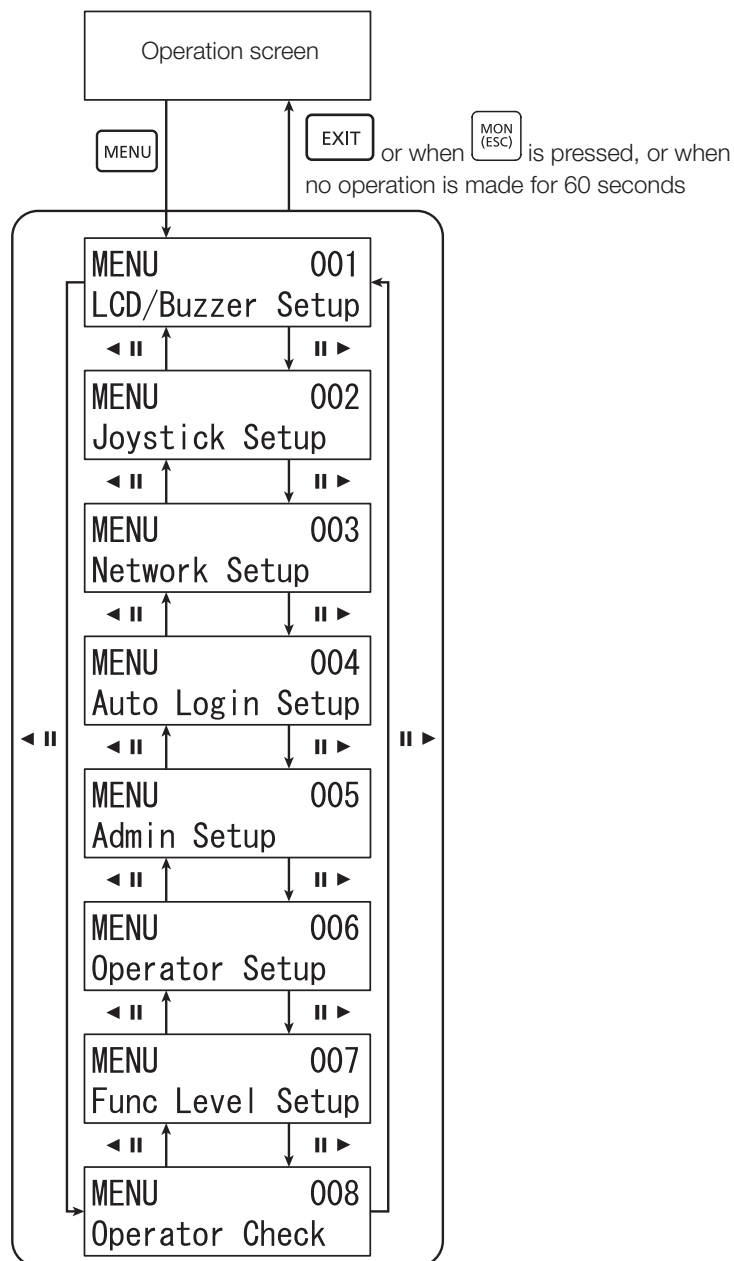

Main unit settings (continued)

List of Settings Menus

Number	Displayed messages	Function description
001	MENU 001 LCD/Buzzer Setup	Display adjustment (brightness, contrast) settings, alarm sound settings, and button operation sound settings can be made.
002	MENU 002 Joystick Setup	The settings for the directions of operation (up, down, left, or right) of the joystick are made here.
003	MENU 003 Network Setup	Network settings (IP address, subnet mask, and default gateway of this equipment, the IP address of the destination of connection, the communication mode and the key for communication) are made here. It is necessary to log in with the administrator ID.
004	MENU 004 Auto Login Setup	The auto login and auto logout settings are made here. It is necessary to log in with the administrator ID.
005	MENU 005 Admin Setup	The administrator (administrator ID, password) are set here. It is necessary to log in with the administrator ID.
006	MENU 006 Operator Setup	New registration of operators (a maximum of 16 users), and modification and cancellation of the parameters (user ID, password, function level) of registered users are made here. It is necessary to log in with the administrator ID.
007	MENU 007 Func Level Setup	The settings (3 levels) of the function level (the restrictions on the main unit operations that the operator can use) are made here. It is necessary to log in with the administrator ID.
008	MENU 008 Operator Check	The confirmation of the settings of registered operators (user ID, password) are made here. It is necessary to log in with the administrator ID.

Method of Using Settings Menus

The method of using the settings menus is described here.

Operation procedure

1 Press 

The selection screen of the settings menu is displayed.

Function name  Function number

2 Select the menu to be set

Select the menu using  or .



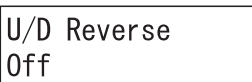

3 Press 

The settings screen of the settings menu is displayed.



Note:

- In the settings screen, the screen returns to the immediately previous screen when  or  is pressed.



4 Settings are made for the selected menu

The method of operation differs depending on the menu. For details, refer to the descriptions of the selected menu.

Note:

- If a wrong number is input during the setting, delete the number by pressing .

5 Press  or 

The display returns to the operation screen.

Depending on the menu function, it will only be possible for an administrator to execute the operations.

When the logged-in user is not an administrator, before the execution screen of the menu function is displayed (Step 3), it is necessary to input the administrator ID and password in that sequence.

1 The administrator ID input screen is displayed



2 Enter the administrator ID using the numeric buttons

The administrator ID that has been input is displayed on the screen.

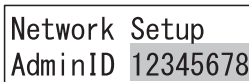

3 Press 

The password input screen is displayed.



4 Enter the administrator password using the numeric buttons

The digits of the password that have been input are displayed as asterisks “*”.



5 Press 

The execution screen of the menu function is displayed. When a wrong administrator ID or password has been input, the blinking message "invalid" will be displayed for a few seconds, and then the display returns to the menu function selection screen. Input again the correct administrator ID and password.

Display / Buzzer Adjustment

You can change the settings of LCD brightness, LCD contrast, alarm buzzer, or button buzzer as follows.

Selection of the item to be set

Select the item to be set.

- 1** From the settings menu, select “001 LCD/Buzzer Setup” (☞ Page 22 Steps 1 to 2)



- 2** Press

The display brightness adjustment screen is displayed.



Display brightness adjustment

Adjust the brightness of the display.

- 1** Select “LCD Bright” from the menu



A numerical value indicating the current brightness setting and a brightness indicating bar are displayed.

Initial value: 11

- 2** Press

The display brightness adjustment screen is displayed.



- 3** Adjust the brightness using or

The display becomes bright when the numerical value in

becomes larger, and becomes darker when the

numerical value in becomes smaller.

Setting range: 1 to 16



- 3** Press or and select the item to be set

Each time or is pressed, the display screen changes successively in the sequence of - the brightness setting menu → contrast setting menu → alarm setting menu → button operation sound setting menu.

- 4** Select the setting item that has to be adjusted, and

press

- 4** Press

The settings confirmation screen is displayed.

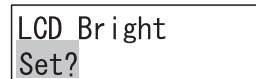

- 5** Press

The settings registration screen is displayed for a few seconds.

After that, the set value is stored, and the screen returns to that of Step 1.

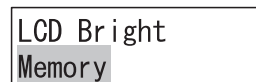

Note:

- It is also possible to increase or decrease the numerical value using also keys.

Main unit settings (continued)

Display contrast adjustment

The contrast level of the display can be adjusted by rotating the Jog Dial.

1 Select "LCD Contrast" from the menu



A numerical value indicating the current contrast setting and a contrast indicating bar are displayed.

Initial value: 11

2 Press

The display contrast adjustment screen is displayed.



3 Adjust the contrast using or

The contrast becomes light when the numerical value in

 becomes larger, and becomes dark when the

numerical value in  becomes smaller.

Setting range: 1 to 16



Alarm sound setting

You can change the duration of the alarm sound*1 by rotating the Jog Dial.

1 Select "Buzzer Alarm" from the menu



The current alarm sound setting is displayed.

Initial value: 2s (2 seconds)

2 Press

The alarm sound setting screen is displayed.



3 Adjust the duration of alarm sound using



The numerical value becomes larger with , and the

numerical value becomes smaller with .

Setting range: Off, 1s (1 second) to 30s (30 seconds), 40s (40 seconds), 50s (50 seconds), and 60s (60 seconds).

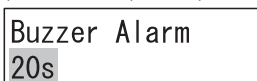

4 Press

The settings confirmation screen is displayed.





5 Press

The settings registration screen is displayed for a few seconds.

After that, the set value is stored, and the screen returns to that of Step 1.



Note:

- It is also possible to increase or decrease the numerical value using also   keys.

4 Press

The settings confirmation screen is displayed.



5 Press

The settings registration screen is displayed for a few seconds.

After that, the set value is stored, and the screen returns to that of Step 1.



*1 Not yet supported. (As of November 2019)

Main unit settings (continued)

Button operation sound setting

This is the setting of whether or not the button operation sound is produced, and whether or not an error sound is produced when an error message such as “Invalid” or “Prohibited” is displayed.

1 Select “Buzzer Operation” from the menu

Buzzer Operation
On

The current button operation sound setting is displayed.
Initial value: On

2 Press

The button operation sound setting screen is displayed.

Buzzer Operation
On

3 With or change the button operation sound On/Off

Buzzer Operation
Off

4 Press

The settings confirmation screen is displayed.

Buzzer Operation
Set?

5 Press

The settings registration screen is displayed for a few seconds.

After that, the set value is stored, and the screen returns to that of Step 1.

Buzzer Operation
Memory

Joystick settings

When panning and tilting the camera set in the PC software by operating the joystick, the setting of whether to make the direction of operation and the direction of movement of the camera image (up/down, left/right) the same or opposite to each other is made as follows.

Selection of the item to be set

Operation procedure

1 From the settings menu, select “002 Joystick Setup” (Page 22 Steps 1 to 2)



MENU 002
Joystick Setup

2 Press

The joystick up/down operation reversal setting screen is displayed.

U/D Reverse
Off

3 Press or and select the item to be changed

Each time  or  is pressed, the joystick up/down operation reversal setting, or the joystick left/right operation reversal setting is selected.

4 Press

The execution screen of the menu function is displayed.

Main unit settings (continued)

Joystick up/down operation reversal setting

When tilting the camera set in the PC software by operating the joystick, the setting of whether to make the direction of operation opposite to the direction of movement of the camera image (up/down) is made as follows.

- When this setting is Off (not reversing), the direction of moving the joystick will be the same as the direction of movement of the camera image.
- When this setting is On (reversing), the direction of moving the joystick will be opposite to the direction of movement of the camera image.

Operation procedure

1 Select "U/D Reverse" from the menu

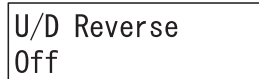

The current joystick up-down operation reversal setting is displayed.

Initial value: Off (Not reversing)



2 Press

The joystick up/down operation reversal setting screen is displayed.

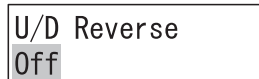

3 With [Left Arrow] or [Right Arrow] change the joystick up/down operation reversal On/Off

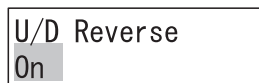

4 Press

The settings confirmation screen is displayed.



5 Press

The settings registration screen is displayed for a few seconds.

After that, the set value is stored, and the screen returns to that of Step 1.



Joystick left/right operation reversal setting

When panning the camera set in the PC software by operating the joystick, the setting of whether to make the direction of operation opposite to the direction of movement of the camera image (left/right) is made as follows.

- When this setting is made Off (not reversing), the direction of moving the joystick will be the same as the direction of movement of the camera image.
- When this setting is made On (reversing), the direction of moving the joystick will be opposite to the direction of movement of the camera image.

Operation procedure

1 Select "L/R Reverse" from the menu

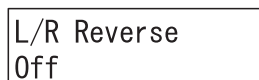

The current joystick left/right operation reversal setting is displayed.

Initial value: Off (Not reversing)



2 Press

The joystick left/right operation reversal setting screen is displayed.

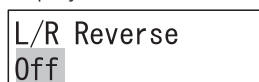

3 With [Left Arrow] or [Right Arrow] change the joystick left/right operation reversal On/Off

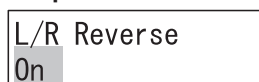

4 Press

The settings confirmation screen is displayed.

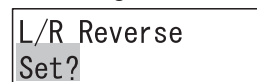

5 Press

The settings registration screen is displayed for a few seconds.

After that, the set value is stored, and the screen returns to that of Step 1.



Network settings

The procedure for changing the network settings is given below.

Important:

- When exiting after changing the network settings, the equipment reboots after displaying the message "Auto Restart" for a few seconds, and the login screen is displayed.

Selection of the item to be set

Operation procedure

- From the settings menu, select "003 Network Setup" (☞ Page 22 Steps 1 to 2)



MENU 003
Network Setup

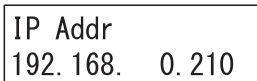

- Press 

The screen for setting the IP address of this equipment is displayed.



IP Addr
192.168. 0.210

- Press  or , and select the item to be changed

Each time  or  is pressed, the screens for - setting the IP address of this equipment, setting of the subnet mask, setting the default gateway, setting the IP address of the destination of connection, setting the communication mode with the destination of connection, and setting the key for communication with the destination of communication are displayed successively in that sequence.

- Press 

The execution screen of the menu function is displayed.

When the logged-in user is not an administrator, before the execution screen of the menu function is displayed (Step 2), it is necessary to input the administrator ID and password in that sequence.

For details of the method of inputting, refer to "Method of Using the Settings Menus" (☞ Page 22).

Common operation of IP address, subnet mask, and default gateway

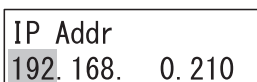

Numerical input



IP Addr
192.168. 0.210

The blinking portion can be changed.

Adjust the cursor to the numeral to be changed, and the numeral is changed when an input is made using the numeric buttons.

The cursor can be moved to the left or right using  or .

Input a value from 0 to 255 in nnn.

The numerical values can be increased or decreased using

the   keys.

Error messages

When a wrong numerical value (other than 0 to 255) is input, the message "Out Of Range" is displayed, and the display returns to the immediately previous setting screen. Input again the correct numerical value (0 to 255).

Main unit settings (continued)

Setting the IP address of this equipment

The IP address of this equipment is set here.

Operation procedure

1 Select "IP Address" from the menu

IP Addr
192.168. 0.210

The current IP address of this equipment is displayed.
Initial value: 192.168.0.210

2 Press

The screen for setting the IP address of this equipment is displayed.

IP Addr
192.168. 0.210

3 Input the IP address (nnn.nnn.nnn.nnn) using the numeric buttons

4 Press

When the IP address is input correctly, the settings confirmation screen is displayed.

IP Addr
Set?

5 Press

The settings registration screen is displayed for a few seconds.

After that, the set value is stored, and the screen returns to that of Step 1.

IP Addr
Memory

Setting the subnet mask of this equipment

The subnet mask of this equipment is set here.

Operation procedure

1 Select "Subnet Mask" from the menu

Subnet Mask
255.255.255. 0

The current subnet mask of this equipment is displayed.
Initial value: 255.255.255.0

2 Press

The subnet mask setting screen is displayed.

Subnet Mask
255.255.255. 0

3 Input the subnet mask (nnn.nnn.nnn.nnn) using the numeric buttons

4 Press

When the subnet mask is input correctly, the settings confirmation screen is displayed.

Subnet Mask
Set?

5 Press

The settings registration screen is displayed for a few seconds.

After that, the set value is stored, and the screen returns to that of Step 1.

Subnet Mask
Memory

Main unit settings (continued)

Setting the default gateway

The default gateway is set here.

Operation procedure

1 Select "Gateway" from the menu

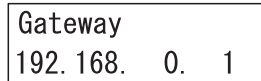

```
Gateway
192.168. 0. 1
```

The current default gateway is displayed.

Initial value: 192.168.0.1

2 Press

The default gateway setting screen is displayed.

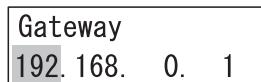

```
Gateway
192.168. 0. 1
```

3 Input the default gateway (nnn.nnn.nnn.nnn) using the numeric buttons

4 Press

When the default gateway is input correctly, the settings confirmation screen is displayed.

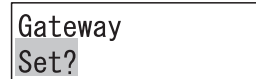

```
Gateway
Set?
```

5 Press

The settings registration screen is displayed for a few seconds.

After that, the set value is stored, and the screen returns to that of Step 1.

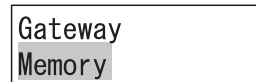

```
Gateway
Memory
```

Setting the IP address of the destination of connection

Set the IP address of the destination of connection (the PC in which the PC software to be connected is installed).

Operation procedure

1 Select "Server IP Addr" from the menu

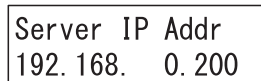

```
Server IP Addr
192.168. 0.200
```

The current IP address setting of the destination of connection is displayed.

Initial value: 192.168.0.200

2 Press

The destination of connection IP address setting screen is displayed.

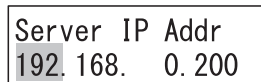

```
Server IP Addr
192.168. 0.200
```

3 Input the address (nnn.nnn.nnn.nnn) using the numeric buttons

4 Press

When the IP address of the destination of connection is input correctly, the settings confirmation screen is displayed.

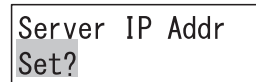

```
Server IP Addr
Set?
```

5 Press

The settings registration screen is displayed for a few seconds.

After that, the set value is stored, and the screen returns to that of Step 1.

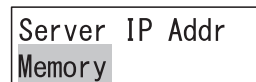

```
Server IP Addr
Memory
```

Setting the communication mode with the destination of communication

Set the communication mode (Normal (normal mode) / CU950 Compatible (mode)) with the destination of communication (the connected PC software). When this setting is made "Normal (normal mode)", in the communication with the connected PC software, communication that protects from security threats is carried out. When this setting is made "CU950 Compatible (mode)", communication with the conventional PC software compatible with CU950*1 can be made.

In order to carry out communication to protect against security threats, use a PC software version that complies with this equipment or conventional PC software after updating it to a version that is compatible with this equipment.

*1 CU950 refers to WV-CU950 or DG-CU950.

Main unit settings (continued)

Operation procedure

1 Select "Communication Mode" from the menu

Communicat Mode
Normal

The current setting of the communication mode with the destination of communication is displayed.
Initial value: Normal (Normal mode)

2 Press

The setting screen for the communication mode with the destination of communication is displayed.

Communicat Mode
Normal

3 With or change the communication mode to Normal/CU950 Compatible

Communicat Mode
CU950 Compatible

4 Press

The settings confirmation screen is displayed.

Communicat Mode
Set?

5 Press

The settings registration screen is displayed for a few seconds.

After that, the set value is stored, and the screen returns to that of Step 1.

Communicat Mode
Memory

Setting the key for communication with the destination of communication

Set the key for communication with the destination of communication (the connected PC software).

Note:

- It is necessary that the key for communication is set to the same value even on the PC software side. For details, refer to the instruction manual of the PC software to be connected.
- The key for communication is necessary when the communication mode is "Normal" (normal mode). This setting is not necessary in the "CU950 Compatible (mode)" mode.

Operation procedure

1 Select "Communication Key" from the menu

Communicat Key
12345678

The current setting of the key for communication with the destination of communication is displayed.

2 Press

The setting screen for the key for communication with the destination of communication is displayed.

Communicat Key
12345678

3 Enter the key for communication with the connected destination using the numeric buttons

The key for communication with the connected destination can be set within the range of values from "00000000" to "99999999" (8 numeric digits).

Communicat Key
87654321

4 Press

If a wrong setting (other than 8 numeric digits) is made for the key for communication with the destination of communication, the message "Set 8 digits num" is displayed for a few seconds, and the display returns to the screen of Step 2. Set the correct key for communication with the destination of connection (8 numeric digits).

The settings confirmation screen is displayed when the correct key for communication with the destination of connection is input.

Communicat Key
Set?

5 Press

The settings registration screen is displayed for a few seconds.

After that, the set value is stored, and the screen returns to that of Step 1.

Communicat Key
Memory

Auto Login/Auto Logout Settings

The auto login and auto logout settings are made here. When auto login is set, the user is automatically logged in when the power supply to this equipment is turned ON. When auto logout has been set, the user is automatically logged out if no operations are made for a particular period of time in the logged-in state. It is not possible to set both Auto Login and Auto Logout together.

It is recommended to operate with auto logout set in order to prevent illegal operation.

Selection of the item to be set

Operation procedure

1 From the settings menu, select “004 Auto Login Setup” (☞ Page 22 Steps 1 to 2)

MENU 004
Auto Login Setup

2 Press 

The current auto login / auto logout settings are displayed.

Auto Login/out
Off

Initial value: Off

3 Press 

The Auto Login / Auto Logout setting screen is displayed.

Auto Login/out
Off

<To activate auto login>

4 By pressing  or , select the user to be logged in automatically

Auto Login/out
Login Operator01



Each time  or  is pressed, the user selected for auto login is changed.

Setting range: Login Admin (administrator login), Login Operator 01 (Operator No. 1 is logged in) to Login Operator 16 (Operator No. 16 is logged in)

<To activate auto logout>

4 By pressing  or , select the time period until logging out automatically

Auto Login/out
Logout 5min

Each time  or  is pressed, the selected time period until automatic logout changes.

Setting range: Logout 5 min (5 minutes), Logout 10min (10 minutes), Logout 30min (30 minutes), Logout 60min (60 minutes), and Logout 120min (120 minutes).

<Clearing the Auto Login/Auto Logout Setting>

4 Press  or  and set to Off

Auto Login/out
Off

5 Press 

The settings confirmation screen is displayed.

Auto Login/out
Set?

6 Press 

The settings registration screen is displayed for a few seconds.

After that, the set value is stored, and the screen returns to that of Step 2.

Auto Login/out
Memory



When the logged-in user is not an administrator, the administrator ID input screen is displayed before the current auto login / auto logout setting is displayed (Step 2), and it will be necessary to input the administrator ID and password.

For details of the method of inputting, refer to “Method of Using the Settings Menu” (☞ Page 22).

Setting of the administrator

The procedure of making the administrator settings is given below.

Note:

- In order to ensure security, set an ID and password that cannot easily be guessed by a third party.
- Take care not to forget the ID and password that have been set, and manage it appropriately away from the eyes of a third party.
- In each input screen, the screen returns to the immediately previous screen when  or  is pressed.

Operation procedure

- 1** From the settings menu, select “005 Admin Setup”
( Page 22 Steps 1 to 2)



- 2** Press 

The current administrator ID setting is displayed.



- 3** Press 

The administrator ID setting screen is displayed.



- 4** Input the administrator ID using the numeric buttons

The administrator ID can be set within the values “00000000” to “99999999” (8 numeric digits).



- 5** Press 

The administrator password input screen is displayed.



- 6** Input the administrator password using the numeric buttons

The administrator password can be set within the values “00000000” to “99999999” (8 numeric digits).



- 7** Press 

The message “Passwd Re-enter” is displayed for a few seconds, and the administrator password input screen is displayed again.



- 8** Input again the administrator password that was input in Step 6

The administrator password can be set within the values “00000000” to “99999999” (8 numeric digits).



- 9** Press 

The settings confirmation screen is displayed.

When the administrator password input in Step 6 and Step 8 are different from each other, the error message “Passwd Mismatch” is displayed for a few seconds, and then the display returns to the screen of Step 3.



- 10** Press 

The settings registration screen is displayed for a few seconds.

After that, the set value is stored, and the screen returns to that of Step 2.

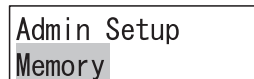

When the logged-in user is not an administrator, the administrator ID input screen is displayed before the current administrator ID setting is displayed (Step 2), and it will be necessary to input the administrator ID and password. For details of the method of inputting, refer to “Method of Using the Settings Menus” ( Page 22).

Operator Registration or Change

You can register new operators or can change the contents of the settings. Up to 16 operators can be registered in the system.

Note:

- In order to ensure security, set an ID and password that cannot easily be guessed by a third party.
- Take care not to forget the ID and password that have been set, and manage it appropriately away from the eyes of a third party.

Operation procedure



- 1** From the settings menu, select “006 Operator Setup” (☞ Page 22 Steps 1 to 2)



```
MENU      006
Operator Setup
```

- 2** Press 

The operator registration / change screen is displayed for a few seconds.

```
Operator Setup
Operator01 Unreg
```

- 3** Press  or , and select the number of the operator to be registered newly or whose contents of settings are to be changed

Each time  or  is pressed, the operator number changes successively from Operator 01 (Operator No. 1) to Operator 16 (Operator No. 16).

When registering a new operator, select an operator number to the right of which “Unreg” is displayed (indicating that it is an unregistered operator number).

- 4** Press 

The user ID setting screen is displayed.

```
Operator01
User ID  _____
```

- 5** Enter the user ID using the numeric buttons

The user ID can be set within the values “00000000” to “99999999” (8 numeric digits).

```
Operator01
User ID  12345678
```

- 6** Press 

The password input screen is displayed.

```
Operator01
Passwd  _____
```

- 7** Enter the password using the numeric buttons

The password can be set within the values “00000000” to “99999999” (8 numeric digits).

```
Operator01
Passwd  *****
```

- 8** Press 

The function level setting screen is displayed.

```
Operator01
Func Level  1
```

Initial value: Level 1

- 9** Press  or  and select the function level

Setting range: 1 (Function level 1) to 3 (Function level 3)

```
Operator01
Func Level  2
```

Refer to “Changing the Function Level” (☞ Page 34) for details of function levels.

- 10** Press 

The settings confirmation screen is displayed.

```
Operator01
Set?
```

- 11** Press 

The settings registration screen is displayed for a few seconds.

After that, the set value is stored, and the screen returns to that of Step 2. (When a new registration is made, the “Unreg” display is hidden.)

```
Operator01
Memory
```



When the logged-in user is not an administrator, the administrator ID input screen is displayed before the operator registration or change screen is displayed (Step 2), and it will be necessary to input the administrator ID and password.



For details of the method of inputting, refer to “Method of Using the Settings Menus” (☞ Page 22).

Deleting an operator

It is possible to delete a registered operator.

Operation procedure

- 1 Press  or , and select the number of the operator whose registration is to be deleted

Every time  or  is pressed, the operator number changes successively from Operator 01 (Operator No. 1) to Operator 16 (Operator No. 16).

To delete the registration, select an operator number to the right of which there is no display of “Unreg” or “Login”.

Operator Setup
Operator02

- 2 Press 

A deleting confirmation screen is displayed.

Operator02
Clear?

- 3 Press 

The deleting screen is displayed for a few seconds.

Operator02
Erased

After that, the display returns to the screen of Step 1 with “Unreg” being displayed to the right of the deleted operator.

Operator Setup
Operator02 Unreg

Changing the Function Level

The content of the function level (function restrictions) is changed in order to set the restrictions on the function buttons that the operator can use.

The function level is present in Tables 1 to 3.

Operation procedure



- 1 From the settings menu, select “007 Func Level Setup” (→ Page 22 Steps 1 to 2)

MENU	007
Func Level Setup	

- 2 Press 

The function level setting screen is displayed.

Func Level Setup	
Func Level	1

- 3 Press  or , and select the table number of the level to be changed



Every time  or  is pressed, the function level changes successively from Function level 1 (Table 1) to Function level 3 (Table 3).

Func Level Setup	
Func Level	2

- 4 Press 

The settings screen of the selected table number is displayed.

Func Level	2
01 MENU	D

- 5 Press  or  and select the function button item to be enabled / disabled

The selected function button item is displayed.

Func Level	2
05 NVR OPERATE	E

Main unit settings (continued)

The function button items that can be selected and the initial settings of the different function levels (table 1 to table 3) are as follows.

Function	Names on the display	Target button (*)	Function Level		
			Level 1	Level 2	Level 3
01	MENU	[MENU]	E	D	D
02	F1-F10	(Left side of main unit front panel) [1-SCREEN] [4-SCREEN] [9-SCREEN] [16-SCREEN] [AUX 1 / OFF] [AUX 2 / OFF] [WIPER / OFF] [ALM RESET] [ALM LIVE] [ALM PLAY]	E	E	E
03	JOYSTICK	(Joystick unit switches) [A] [B] [TOP button] [JOYSTICK] [ZOOM Wheel Controller] [FOCUS FAR] [FOCUS NEAR] [IRIS OPEN] [IRIS CLOSE]	E	E	E
04	DEVICE SEL	(Right side of main unit front panel) [MULTI SCRNR] [+] [-] [GROUP] [PRESET / PGM] [SEQ / STOP] [0] to [9] [MON (ESC)] [CAM (SET)]	E	E	E
05	NVR OPERATE	(Center of main unit front panel) [GO TO LAST] [STOP] [REC / REC STOP] [REV PLAY] [PLAY] [FF] [PREV IMAGE] [PAUSE] [NEXT IMAGE] [REV SKIP / PREV RECORD] [SKIP / NEXT RECORD]	E	E	D

(*) There are no restrictions on the buttons that have not been written here ([ENTER/LOGOUT] [EXIT] [SHIFT] [CLEAR] buttons) as well as on the logout function (SHIFT) + [ENTER] button). In addition, the restrictions on all buttons during the execution of menu functions will be treated the same as the setting for the [MENU] button (for example, in the case of the setting 01 MENU = "Enabled (E)", 04 DEVICE SEL = "Disable (D)", during the execution of the menu function by pressing the [MENU] button under normal operation, the target switch of 04 DEVICE SEL ([0] button, etc.) is treated as "Enable (E)").

Note: E means Enable, and D means Disable.

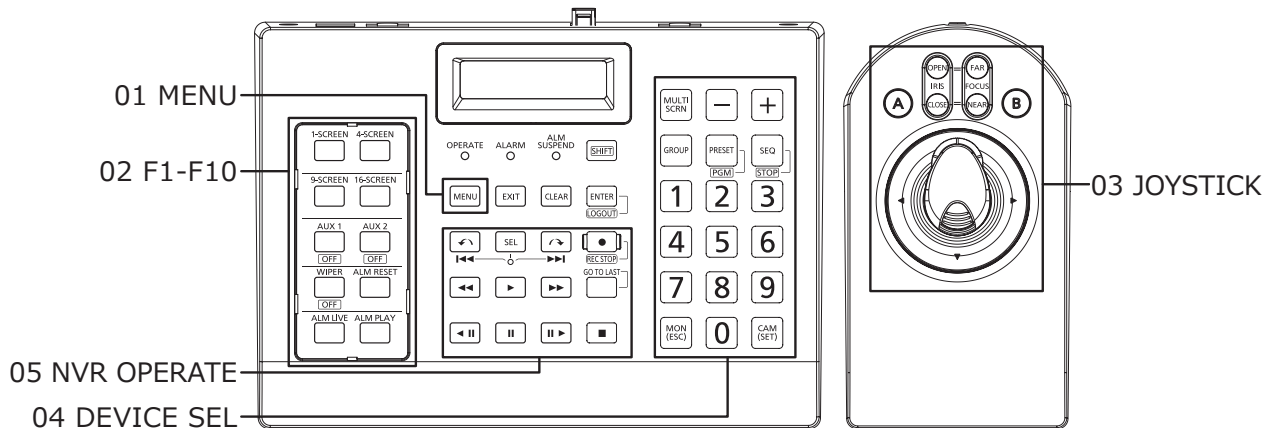



Main unit settings (continued)

6 Move the cursor to the right using the 

This is the screen for selecting “Enable: E / Disable: D”.

```
Func Level      2
05 NVR OPERATE E
```

The display returns to the selection screen when  or  is pressed.

7 Press  or  and select Enable (E) / Disable (D)

```
Func Level      2
05 NVR OPERATE D
```

8 Press 

The settings confirmation screen is displayed.

```
Func Level      2
Set?
```

9 Press 

The settings registration screen is displayed for a few seconds.

After that, the set value is stored, and the screen returns to that of Step 2.

Repeat Step 2 to Step 9 when changing the restrictions of several functions.

```
Func Level      2
Memory
```

When the logged-in user is not an administrator, before the function level settings screen is displayed (Step 2), it is necessary to input the administrator ID and password in that sequence.

For details of the method of inputting, refer to “Method of Using the Settings Menus” ( Page 22).

Confirming the operator settings

It is possible to confirm the user ID and password of the registered operators.

Operation procedure



1 From the settings menu, select “008 Operator Check” ( Page 22 Steps 1 to 2)



```
MENU      008
Operator Check
```

2 Press 

The operator settings (user ID and password) confirmation screen is displayed.

```
Operator Check
Operator01 Unreg
```

3 Press  or , and select the number of the operator whose settings are to be checked

Every time  or  is pressed, the operator number changes successively from Operator 01 (Operator No. 1) to Operator 16 (Operator No. 16).

```
Operator Check
Operator02
```

When checking the settings of an operator, select an operator number to the right of which “Unreg” is not displayed (indicating that it is an already registered operator).

4 Press 

The settings (user ID and password) display screen of the selected operator number is displayed.

```
User ID  12345678
Passwd   12345678
```

When the logged-in user is not an administrator, the administrator ID input screen is displayed before the operator settings (user ID and password) confirmation screen is displayed (Step 2), and it will be necessary to input the administrator ID and password.

For details of the method of inputting, refer to “Method of Using the Settings Menus” ( Page 22).

Operation

Connecting with a PC

This unit and a PC in which the PC software has been installed are connected via a switching hub.

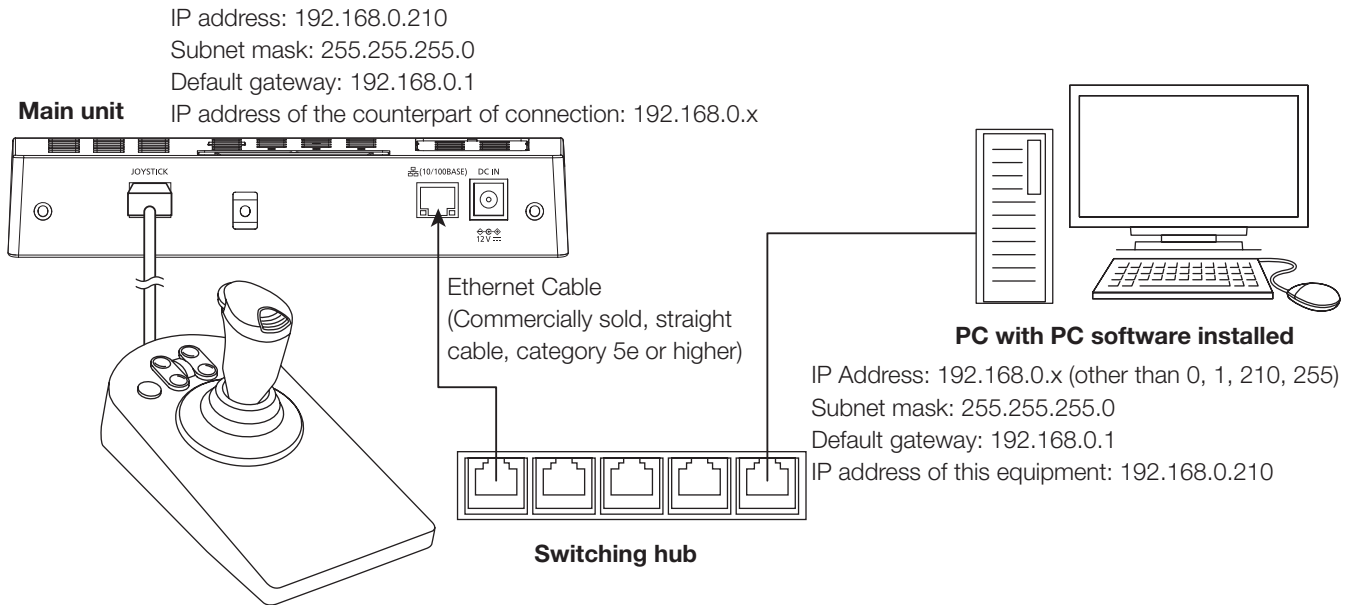

Note:

- When connecting with the PC software, it is necessary to carry out setting of the key for communication apart from the network settings (☞ Page 30)

Operating the PC software

Using this equipment it is possible to operate the PC software that is connected.

The operation of the PC software differs depending on the PC software that is connected and its version.

For details, refer to the instruction manual of the PC software to be connected.

Maintenance

Joystick Unit Adjustment

The method of calibrating (hereafter referred to as 'adjusting') the joystick unit (joystick, and zoom wheel controller) is explained below.

Normally there is no need to carry out adjustment. Carry out adjustment in the following situations.

- When the camera image moves (pans or tilts) even though the joystick has not been operated (the joystick is not held and has returned to the central position).
- When the zooming of the camera image changes even though the zoom wheel controller has not been operated (the zoom wheel controller is not held and has returned to the central position).

Adjustment of Joystick

The joystick is adjusted as follows.

Note:

- The tilt and pan state values displayed during adjustment change according to how the joystick is moved in the up, down, left, or right directions. Further, this may change depending on the equipment, or every time the adjustment is made.
- During adjustment, when returning the joystick to the center, do not return it slowly, but quickly release your hand as if to flip it. If the joystick is returned slowly, it may stop not at the center but at a position that is slightly off from the center.

Operation procedure

1 Switch ON the power supply while simultaneously

pressing **9** + **MON (ESC)**

The administrator ID input screen is displayed.



2 Enter the administrator ID using the numeric buttons

The administrator ID that has been input is displayed on the screen.

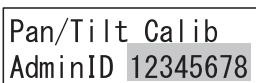

3 Press **CAM (SET)**

The password input screen is displayed.



4 Enter the administrator password using the numeric buttons



5 Press **CAM (SET)**

When a wrong administrator ID or password has been input, the blinking message "invalid" is displayed for a few seconds, and then the display returns to the administrator ID input screen. Input again the correct administrator ID and password.

When the administrator ID and password have been input correctly, the pan/tilt calibration settings confirmation screen is displayed.

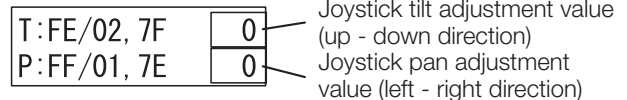

Joystick in the central position

The joystick tilt adjustment value is displayed in the top right part of the screen.

When the joystick is moved in the up and down directions, the tilt adjustment value displayed changes in the range of -64 (joystick moved to the bottom end position) to 0 (hand released from the joystick letting the joystick return to the central position) to 64 (joystick moved to the top end position).

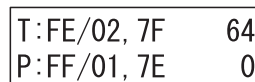

The state in which the joystick is moved to the top end position

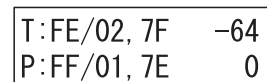

The state in which the joystick is moved to the bottom end position

Maintenance (continued)

The joystick pan adjustment value is displayed in the bottom right part of the screen.

When the joystick is moved in the left and right directions, the pan adjustment value displayed changes in the range of -64 (joystick moved to the left end position) to 0 (hand released from the joystick letting the joystick return to the central position) to 64 (joystick moved to the right end position).

T: FE/02, 7F	0
P: FF/01, 7E	64

The state in which the joystick is moved to the right end position

T: FE/02, 7F	0
P: FF/01, 7E	-64

The state in which the joystick is moved to the left end position

When the adjustment value displayed (up-down direction, left-right direction) is not in the range -64 to 0 to 64 as described above when the joystick is operated in the up, down, left, and right directions and at the center, since it is likely that the adjustment of the joystick has shifted, carry out adjustment of the joystick according to the following procedure.

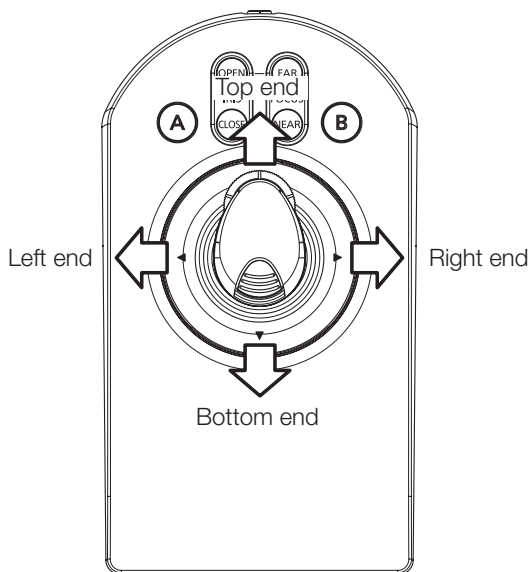

6 Press



The tilt (top end) setting screen is displayed.

The joystick tilt state value is displayed in the top right part of the screen.

T: ---/---, ---	7F
P: ---/---, ---	

7 Keep the joystick moved to the top end position

The tilt state value in the top right part of the screen changes.

T: ---/---, ---	FE
P: ---/---, ---	

8 Press



As the cursor moves, the top end tilt value is simultaneously displayed at its position and the tilt (bottom end) setting screen is displayed.

T: FE/---, ---	FE
P: ---/---, ---	

9 Keep the joystick moved to the fully downward direction (bottom end)

The tilt state value in the top right part of the screen changes.

T: FE/---, ---	02
P: ---/---, ---	

10 Press



As the cursor moves, the bottom end tilt value is simultaneously displayed at its position and the tilt (central) setting screen is displayed.

T: FE/02, ---	02
P: ---/---, ---	

11 Release the joystick from your hand and let it return to its central position

The tilt state value in the top right part of the screen changes.

T: FE/02, ---	7F
P: ---/---, ---	

12 Press



As the cursor moves, the central tilt value is simultaneously displayed at its position and the pan (right end) setting screen is displayed.

The joystick pan state value is displayed in the bottom right part of the screen.

T: FE/02, 7F	
P: ---/---, ---	7E

13 Keep the joystick in the right end position

The pan state value at the bottom right part of the screen changes.

T: FE/02, 7F	
P: ---/---, ---	FF

14 Press



As the cursor moves, the right end pan value is simultaneously displayed at its position and the pan (left end) setting screen is displayed.

T: FE/02, 7F	
P: FF/---, ---	FF

Maintenance (continued)

15 Keep the joystick in the left end position

The pan state value at the bottom right part of the screen changes.

T: FE/02, 7F	
P: FF/01, --	01

16 Press



As the cursor moves, the bottom end pan value is simultaneously displayed at its position and the pan (central) setting screen is displayed.

T: FE/02, 7F	
P: FF/01, --	01

17 Release the joystick from your hand and let it return to its central position

The pan state value at the bottom right part of the screen changes.

T: FE/02, 7F	
P: FF/01, --	7E

18 Press



The setting confirmation screen is displayed simultaneously with the central pan value being displayed at the position of the cursor.

T: FE/02, 7F	Set
P: FF/01, 7E	?

19 Press



The settings registration screen is displayed for a few seconds.

T: FE/02, 7F	Mem
P: FF/01, 7E	ory

After that, the display changes to the pan/tilt calibration settings confirmation screen (the set values are reflected).

T: FE/02, 7F	0
P: FF/01, 7E	0

The joystick tilt adjustment value is displayed in the top right part of the screen.

When the joystick is moved in the up and down directions, the tilt adjustment value displayed changes in the range of -64 (joystick moved to the bottom end position) to 0 (hand released from the joystick letting the joystick return to the central position) to 64 (joystick moved to the top end position).

The joystick pan adjustment value is displayed in the bottom right part of the screen.

When the joystick is moved in the left and right directions, the pan adjustment value displayed changes in the range of -64 (joystick moved to the left end position) to 0 (hand released from the joystick letting the joystick return to the central position) to 64 (joystick moved to the right end position).

Note:

- If or is pressed, the settings confirmation screen is not displayed, and the display changes to the pan/tilt calibration settings confirmation screen (the set values are not reflected).

20 Confirm the pan/tilt calibration settings

When the joystick is moved to the top end position, confirm that the tilt adjustment value displayed becomes 64.

T: FE/02, 7F	64
P: FF/01, 7E	0

When the joystick is moved to the bottom end position, confirm that the tilt adjustment value displayed becomes -64.

T: FE/02, 7F	-64
P: FF/01, 7E	0

When the joystick is moved to the right end position, confirm that the pan adjustment value displayed becomes 64.

T: FE/02, 7F	0
P: FF/01, 7E	64

When the joystick is moved to the left end position, confirm that the pan adjustment value displayed becomes -64.

T: FE/02, 7F	0
P: FF/01, 7E	-64

When the joystick is released from the hand and allowed to return to its central position, confirm that the tilt adjustment value and the pan adjustment value displayed both become 0.

T: FE/02, 7F	0
P: FF/01, 7E	0

When the tilt adjustment value and the pan adjustment value displayed when the joystick is operated do not become as described above, since it is likely that the adjustment of the joystick has not been made correctly. In this case, turn off the power and carry out the Step 1 to Step 20 again.

21 Turn off the power

After making the adjustments, switch off the power supply and end the calibration.

Zoom wheel controller adjustment

The zoom wheel controller is adjusted (zoom calibration)

Note:

- The displayed zoom wheel controller state value changes according to the direction of rotating the zoom wheel controller.
- The displayed zoom wheel controller state value may change depending on the equipment, or every time the adjustment is made.
- When returning the zoom wheel controller to the center, do not return it slowly, but quickly release your hand as if to flip it. If the joystick is returned slowly, it may stop not at the center but at a position that is slightly off from the center.

Operation procedure

1 Switch ON the power supply while simultaneously

pressing **8** + **MON (ESC)**

The administrator ID input screen is displayed.



2 Input the administrator ID using the numeric buttons

The administrator ID that has been input is displayed on the screen.

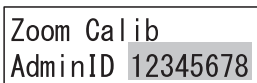

3 Press **CAM (SET)**

The password input screen is displayed.



4 Enter the administrator password using the numeric buttons

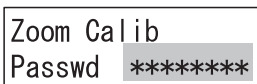

5 Press **CAM (SET)**

When a wrong administrator ID or password has been input, the blinking message "invalid" is displayed for a few seconds, and then the display returns to the administrator ID input screen. Input again the correct administrator ID and password.

When the administrator ID and password have been input correctly, the zoom wheel controller calibration settings confirmation screen is displayed.

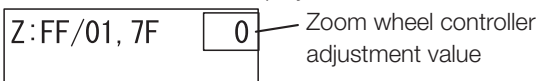

Zoom wheel controller in the central state

The zoom wheel controller adjustment value is displayed in the top right part of the screen.

When the zoom wheel controller is moved in the left and right directions, the adjustment value displayed changes in the range of -4 (when rotated to the left end (wide angle end) position) to 0 (hand released from the zoom wheel controller letting it return to the central position) to 4 (zoom wheel controller moved to the right end (telephoto) position).

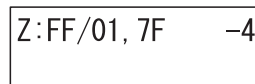

The state in which the zoom wheel controller is rotated to the left end (wide angle end)

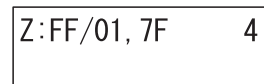

The state in which the zoom wheel controller is rotated to the right end (telephoto end)

When the zoom wheel controller is rotated to the left and right and to the center, if the adjustment value displayed is not in the range -4 to 0 to 4 as described above, since it is likely that the adjustment of the zoom wheel controller has shifted, carry out adjustment of the zoom wheel controller according to the following procedure.

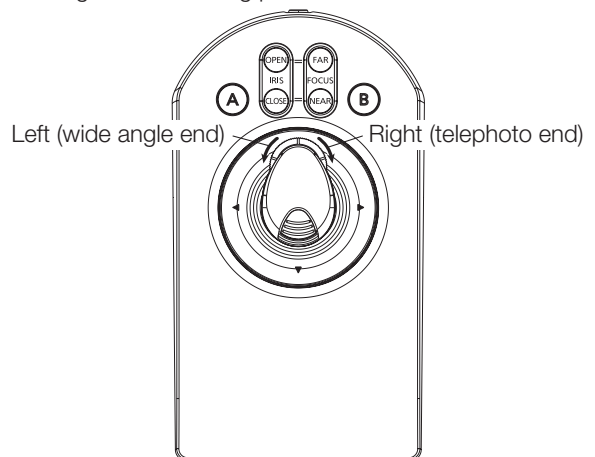

6 Press **CAM (SET)**

The zoom wheel controller (telephoto end) settings screen is displayed.

The zoom wheel controller state value is displayed in the top right part of the screen.

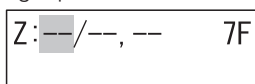

Maintenance (continued)

9 Keep the zoom wheel controller rotated to the right end (telephoto end)

The zoom wheel controller state value displayed in the top right part of the screen changes.

Z: --/--, -- FF

8 Press



As the cursor moves, the telephoto end zoom wheel controller value is simultaneously displayed at its position and the zoom wheel controller (wide angle end) setting screen is displayed.

Z: FF/--, -- FF

10 Keep the zoom wheel controller rotated to the left end (wide angle end)

The zoom wheel controller state value displayed in the top right part of the screen changes.

Z: FF/--, -- 01

10 Press



As the cursor moves, the wide angle end zoom wheel controller value is simultaneously displayed at its position and the zoom wheel controller (central) setting screen is displayed.

Z: FF/01, -- 01

11 Release the zoom wheel controller from your hand and let it return to its central position

The zoom wheel controller state value displayed in the top right part of the screen changes.

Z: FF/01, -- 7F

12 Press



The setting confirmation screen is displayed simultaneously with the central zoom controller value being displayed at the position of the cursor.

Z: FF/01, 7F Set ?

13 Press



The settings registration screen is displayed for a few seconds.

Z: FF/01, 7F Memory

After that, the display changes to the zoom calibration settings confirmation screen (the set values are reflected).

Z: FF/01, 7F 0 Zoom wheel controller adjustment value

The zoom wheel controller adjustment value is displayed in the top right part of the screen.

When the zoom wheel controller is moved in the left and right directions, the adjustment value displayed changes in the range of -4 (when rotated to the left end (wide angle end) position) to 0 (hand released from the zoom wheel controller letting it return to the central position) to 4 (zoom wheel controller moved to the right end (telephoto) position).

Note:

- If or is pressed, the settings registration screen is not displayed, and the display changes to the zoom wheel controller calibration settings confirmation screen (the set values are not reflected).

14 Confirm the zoom wheel controller calibration settings

When the zoom wheel controller is rotated to the right end (telephoto end) position, confirm that the adjustment value displayed becomes 4.

Z: FF/01, 7F 4

When the zoom wheel controller is rotated to the left end (wide angle end) position, confirm that the adjustment value displayed becomes -4.

Z: FF/01, 7F -4

When the zoom wheel controller is released from the hand and allowed to return to its central position, confirm that the adjustment value displayed becomes 0.

Z: FF/01, 7F 0

When the zoom wheel controller is operated and the adjustment value displayed does not become as described above, since it is likely that the adjustment of the zoom wheel controller has not been made correctly. In this case, turn off the power and carry out the Step 1 to Step 14 again.

15 Turn off the power

After making the adjustments, switch off the power supply and end the calibration.

All Reset

When an all reset is carried out, the main unit settings that can be set using the menu functions of this equipment are all reset to their initial states.

Since the main unit settings are reset to the initial states, first-time setup will be necessary when the power to this equipment is switched ON next and this equipment is started again. For details, refer to “First-time Setup” (☞ Page 16).

The settings that are initialized by an all reset are the following.

- Display/Buzzer Adjustment
- Joystick settings
- Network settings
- Auto Login/Auto Logout Setting
- Settings of the administrator
- Settings of operators
- Function Level settings

Operation procedure

1 Switch ON the power supply while keeping pressed



The all reset execution confirmation screen is displayed.

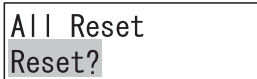

2 Press 

The all reset execution screen is displayed for a few seconds.

After that, the display transitions to the all reset execution completion screen.

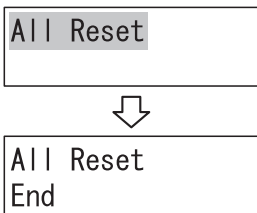

3 Switch OFF the power supply

Troubleshooting

Before asking for repairs, check the symptoms with the following table.

Contact your dealer if a problem cannot be solved even after checking and trying the solution in the table or a problem is not described below.

Symptom	Cause/solution	Ref. pages
The power supply to this equipment is not turned on.	<ul style="list-style-type: none"> Has the power supply plug been inserted securely in the AC power supply socket? Check if it has been connected. 	–
	<ul style="list-style-type: none"> Has the power supply cord been inserted securely in the AC adapter? Check if it has been inserted properly. 	14
	<ul style="list-style-type: none"> Has the DC plug been inserted securely in the power supply terminals of this equipment? Check if it has been inserted securely. 	14
The display is dark /the text characters are not displayed properly.	<ul style="list-style-type: none"> Has the display brightness and contrast been set correctly? Check the adjustment values. 	23
Login screen is not displayed.	<ul style="list-style-type: none"> The power supply may have been turned ON while multiple buttons for maintenance functions are pressed down. Confirm that no buttons are being pressed down, and turn on the power again. 	38
Cannot control cameras with the joystick.	<ul style="list-style-type: none"> The joystick unit and the main unit may not have been connected correctly. Check the connection. 	14
	<ul style="list-style-type: none"> The user who has logged into the system may not be authorized with the function level for operating those buttons. Check the function level settings of the logged in user. 	34
Panning, tilting, or zooming is activated even when you are not controlling the joystick.	<ul style="list-style-type: none"> The joystick unit and the main unit may not have been connected correctly. Check the connection. 	14
	<ul style="list-style-type: none"> Has the joystick unit been calibrated? Carry out calibration. 	38
The speed of panning and tilting vary depending on the direction of tilting the joystick.	<ul style="list-style-type: none"> Has the joystick unit been calibrated? Carry out calibration. 	38
User cannot log into the system.	<ul style="list-style-type: none"> Have you input the user ID correctly? Input again the correct user ID. 	36
	<ul style="list-style-type: none"> Have you input the password correctly? If a mistake is made in inputting the password, the display returns to the login screen, and input again starting from the user ID. 	36
Buzzer does not sound.	<ul style="list-style-type: none"> Have the alarm sound setting and the button operation sound setting been turned on? Check the setting. 	24
There is a button that causes no action even when it is pressed.	<ul style="list-style-type: none"> Is it a button that can be used for the selected group or camera? The functions that can be executed differ depending on the units selected. For details, refer to the instruction manual of the PC software. 	–
	<ul style="list-style-type: none"> The user who has logged into the system may not be authorized with the function level for operating those buttons. Check the function level settings of the logged-in user. 	34

Troubleshooting (continued)

Inspect the power cord, power plug and connectors periodically.

Symptom	Cause/solution	Ref. pages
The power cord insulation is damaged.	<ul style="list-style-type: none">The power cord, connector, or power plug is damaged. This may result in electric shock or a fire. Unplug the power plug from the AC outlet immediately, and refer to qualified service personnel.	-
The power cord, plug and connectors get hot during use.		
The power cord gets hot when bent or stretched.		

Specifications

• Main body

Power source:	DC 12 V 250 mA
Power consumption:	With included AC Adapter 3 W (DC 12 V 250 mA)
Ambient operating temperature:	0 °C - 50 °C {32 °F - 122 °F}
Ambient operating humidity:	5 % to 90 % (non condensing)
Display:	LCD (16 characters, 2 lines), Adjustable Brightness and Contrast
Network port:	10BASE-T/100BASE-TX (RJ-45) × 1
Joystick port:	Dedicated interface (RJ-45) × 1
Serial port (for maintenance)	
Dimensions:	
Main unit	237 mm (W) × 45 mm (H) × 173 mm (D) {9-11/32 inches (W) × 1-25/32 inches (H) × 6-13/16 inches (D)} (excluding projections)
Joystick unit	113 mm (W) × 121 mm (H) × 206 mm (D) {4-7/16 inches (W) × 4-25/32 inches (H) × 8-1/8 inches (D)} (excluding cable)
Mass:	Main unit: Approx. 840 g {1.85 lbs} Joystick unit: Approx. 640 g {1.41 lbs}
Finish:	Main unit, panel: Resin, Black Joystick unit, base: Resin, Black Joystick unit, joystick: Resin, Black

• AC Adapter (included)

Input voltage:	100 V AC to 240 V AC, 50 Hz / 60 Hz
Output voltage:	DC 12 V 1.5 A
Dimensions:	53 mm (W) × 33 mm (H) × 111 mm (D) {2-3/32 inches (W) × 1-5/16 inches (H) × 4-3/8 inches (D)} (excluding power cord and DC cable)
Mass:	Approx. 166 g {0.37 lbs}

Open Source Software

This software contains third-party software programs licensed under BSD.

Copyright (c) 1992, 1993

The Regents of the University of California. All rights reserved.

Copyright (c) 1990, 1993

The Regents of the University of California. All rights reserved.

Copyright (c) 1992, 1993

The Regents of the University of California. All rights reserved.

This code is derived from software contributed to Berkeley by Chris Torek.

NOTICE:

Since the sockets interface was designed and developed at the University of California, the following copyright is included. Portions of the following definitions are protected by that copyright

Copyright (c) 1982, 1986, 1991, 1993, 1994

The Regents of the University of California. All rights reserved.

(c)UNIX System Laboratories, Inc.

All or some portions of this file are derived from material licensed to the University of California by American Telephone and Telegraph Co. or Unix System Laboratories, Inc. and are reproduced herein with the permission of UNIX System Laboratories, Inc.

Redistribution and use in source and binary forms, with or without modification, are permitted provided that the following conditions are met:

1. Redistributions of source code must retain the above copyright notice, this list of conditions and the following disclaimer.
2. Redistributions in binary form must reproduce the above copyright notice, this list of conditions and the following disclaimer in the documentation and/or other materials provided with the distribution.
3. All advertising materials mentioning features or use of this software must display the following acknowledgement: This product includes software developed by the University of California, Berkeley and its contributors.
4. Neither the name of the University nor the names of its contributors may be used to endorse or promote products derived from this software without specific prior written permission.

THIS SOFTWARE IS PROVIDED BY THE REGENTS AND CONTRIBUTORS "AS IS" AND ANY EXPRESS OR IMPLIED WARRANTIES, INCLUDING, BUT NOT LIMITED TO, THE IMPLIED WARRANTIES OF MERCHANTABILITY AND FITNESS FOR A PARTICULAR PURPOSE ARE DISCLAIMED. IN NO EVENT SHALL THE REGENTS OR CONTRIBUTORS BE LIABLE FOR ANY DIRECT, INDIRECT, INCIDENTAL, SPECIAL, EXEMPLARY, OR CONSEQUENTIAL DAMAGES (INCLUDING, BUT NOT LIMITED TO, PROCUREMENT OF SUBSTITUTE GOODS OR SERVICES; LOSS OF USE, DATA, OR PROFITS; OR BUSINESS INTERRUPTION) HOWEVER CAUSED AND ON ANY THEORY OF LIABILITY, WHETHER IN CONTRACT, STRICT LIABILITY, OR TORT (INCLUDING NEGLIGENCE OR OTHERWISE) ARISING IN ANY WAY OUT OF THE USE OF THIS SOFTWARE, EVEN IF ADVISED OF THE POSSIBILITY OF SUCH DAMAGE.

Disposal of Old Equipment

Only for European Union and countries with recycling systems



This symbol on the products, packaging, and/or accompanying documents means that used electrical and electronic products must not be mixed with general household waste.

For proper treatment, recovery and recycling of old products, please take them to applicable collection points in accordance with your national legislation.

By disposing of them correctly, you will help to save valuable resources and prevent any potential negative effects on human health and the environment.

For more information about collection and recycling, please contact your local authority.

Penalties may be applicable for incorrect disposal of this waste, in accordance with national legislation.

For U.S.A.

Disposal may be regulated in your community due to environmental considerations. For disposal or recycling information, please visit our website.

For U.S. and Canada:

i-PRO Americas Inc.
<https://www.i-pro.com/>

For Europe and other countries:

i-PRO Co., Ltd. Fukuoka, Japan
<https://www.i-pro.com/>

i-PRO EMEA B.V. UK Branch
1010 Cambourne Business Park,
Cambridgeshire CB23 6DP

Authorised Representative in EU:
i-PRO EMEA B.V.
Laarderhoogtweg 25, 1101 EB
Amsterdam, Netherlands

UK
CA

CE